



EN

i-KIR2 MTD reverse-cycle air/water heat pump with DC inverter-driven compressors, domestic hot water production, axial-flow fans and hydronic unit for outdoor installation

r HFC
R-410A



i-KIR2 MTD
0011m ÷ 0061m

U I A	General warnings	3	I A	General technical data	33
U I A	Waiver of liability	3	I A	Operating limits	34
U I A	Fundamental safety rules	3	A	Checking and starting up the unit	36
I A	Receiving and handling the product	4	A	Description of room controller buttons and display	37
U I A	Unit identification	5	A	Operation and functions of the room controller	39
I A	Description of standard unit	6	A	Control and operating characteristics	52
I	Dimensioned drawings	7	A	Maintenance and service	57
I	Minimum clearances	8	A	Shutting down for long periods	62
I A	Heat pump installation	8	A	Routine maintenance	63
I A	Water connections	9	A	Special maintenance	63
I A	Electrical connections	13	A	Disposal	63
I A	Wiring diagrams	14	U I A	Useful information	63
I A	Remote contact terminal diagrams	16	U I A	Installer operations CHECKLIST	64
I A	Installer connections to be performed on the inside module	17			
I A	Installer connections	18			

The following symbols are used in this publication and inside the unit:

U

User



Important



Danger high temperatures

I

Installer



Prohibition

A

Assistance



Danger voltage



Eurovent certification program.

The manufacturer reserves the right to modify the data in this manual without warning.

⚠ These appliances have been designed to chill and/or heat water and must be used in applications compatible with their performance characteristics; these appliances are designed for residential or similar applications.

Incorrect installation, regulation and maintenance or improper use absolve the **manufacturer** from all liability, whether contractual or otherwise, for damage to people, animals or things.

Only those applications specifically indicated in this list are permitted

Read this manual carefully. All work must be carried out by qualified personnel in conformity with legislation in force in the country concerned.

The warranty is void if the above instructions are not respected and if the unit is started up for the first time without the presence of personnel authorised by the Company (where specified in the supply contract) who should draw up a "start-up" report.

The documents supplied with the unit must be consigned to the owner who should keep them carefully for future consultation in the event of maintenance or service.

All repair or maintenance work must be carried out by the Company's Technical Service or qualified personnel following the instructions in this manual.

The air-conditioner must under no circumstances be modified or tampered with as this may create situations of risk. Failure to observe this condition absolves the manufacturer of all liability for resulting damage.

WAIVER OF LIABILITY

This publication is the sole property of **Manufacturer**. Any reproduction or disclosure of such is strictly prohibited without the written authorisation of **Manufacturer**.

This document has been prepared with maximum care and attention paid to the content shown. Nonetheless, **Manufacturer** waives all liability deriving from the use of such document.

Read this document carefully. All work must be performed, components selected and materials used in complete accordance with the legislation in force in material in the country concerned, and considering the operating conditions and intended uses of the system, by qualified personnel.

FUNDAMENTAL SAFETY RULES

Ricordiamo che l'utilizzo di prodotti che impiegano energia elettrica ed acqua, comporta l'osservanza di alcune regole fondamentali di sicurezza quali:

⊗ **The unit must not be used** by children or by unfit persons without suitable supervision.

Do not touch the unit with bare feet or with wet or damp parts of the body.

Never perform any cleaning operations before having disconnected the unit from the mains power supply.

Do not modify safety or control devices without authorisation and instructions from the manufacturer.

Do not pull, detach or twist the electrical cables coming from the unit, even when disconnected from the mains electricity supply.

Do not open doors or panels providing access to the internal parts of the unit without first ensuring that the switch QF1 is in the OFF position (see the wiring diagram).

Do not introduce pointed objects through the air intake and outlet grills.

Do not dispose of, abandon or leave within reach of children packaging materials (cardboard, staples, plastic bags, etc.) as they may represent a hazard.

⚠ **Respect safety distances** between the unit and other equipment or structures. Guarantee adequate space for access to the unit for maintenance and/or service operations.

Power supply: the cross section of the electrical cables must be adequate for the power of the unit and the power supply voltage must correspond with the value indicated on the respective units. All units must be earthed in conformity with legislation in force in the country concerned.

Terminals from 41 to 52, may be live even when the unit has been disconnected. Check for voltage before proceeding.

Water connections should be carried out as indicated in the instructions to guarantee correct operation of the unit. Add glycol to the water circuit if the unit is not used during the winter or the circuit is not emptied.

Handle the unit with the utmost care (see weight distribution table) to avoid damage.

VISUAL INSPECTION

When the items are consigned by the carrier:

- make sure that the goods delivered correspond to the description on the delivery note, comparing this against the data on the packaging label.
- make sure the packaging and the unit are intact.

If damage or missing components are noted, indicate this on the delivery note. A formal complaint should be sent via fax or registered post to the After Sales Department within eight days from the date of receipt of the items.

STORING THE UNITS

The units must be stored sheltered from direct sunlight, rain, wind or sand.

Avoid exposing the units to direct sunlight, as the pressure inside the refrigerant circuit may reach dangerous values and cause the activation of the safety valves, where fitted.

The units cannot be stacked.

⚠ The packaging should not be removed until the unit is located in the installation site.

HANDLING PACKAGED UNITS

The unit should always be handled by qualified personnel using equipment adequate for the weight of the unit, in compliance with the safety standards in force (and subsequent amendments).

• Lifting by forklift (1)

Insert the forks under the long side of base, opening the forks as far as possible.

• Lifting by crane (2)

Use slings with hooks suitable for the weight being lifted. Secure the hook to the lifting bracket fixed to the unit, use always four equal length slings, as shown in the figure, to ensure the weight is balanced.

⚠ The weight of the unit is biased towards the compressor side.

During transport, the unit should be kept in a vertical position.

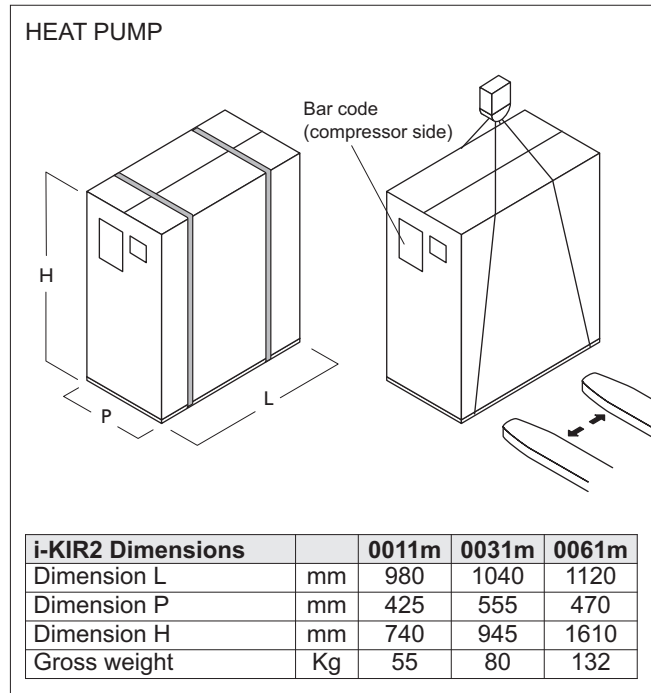

REMOVING THE PACKAGING

The packaging must be removed by the operator using suitable protective equipment (gloves, glasses, etc.).

Take special care not to damage the unit. Observe the local standards in force as regards disposal of the packaging, using specialist collection or recycling centres.

⊘ Do not dispose of packaging materials in the environment or leave them within reach of children as they may represent a hazard.

Envelope A located in the inside module contains:

- user manual;
- installation - user - maintenance manual

Envelope B located in the outside module contains:

- Condensate drain elbow fitting
- CE declaration

Make sure the components listed above are not lost or misplaced.

⚠ The installation - user - maintenance manual is an integral part of the unit and should therefore be read and kept carefully.

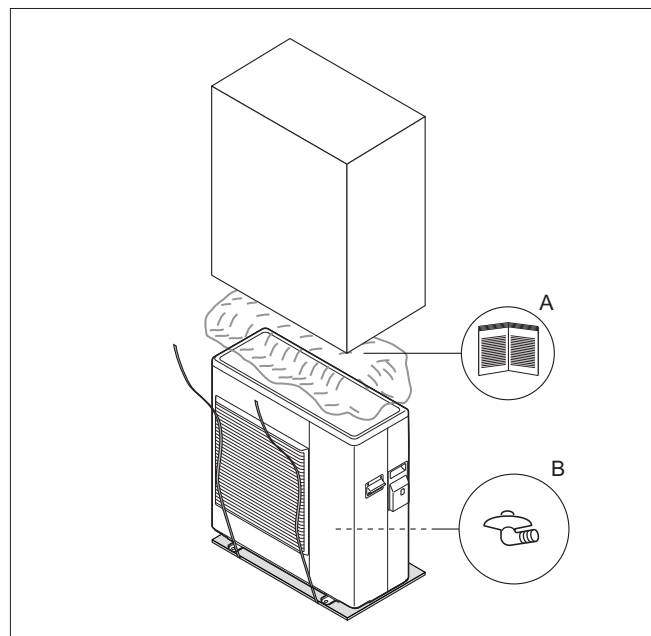

HANDLING UNPACKAGED UNITS

When the packaging has been removed:

- Remove the base.
- Fit the vibration damping feet (accessories).
- Handle the unit using equipment that is suitable for its weight (forklift or crane), in compliance with the safety standards in force (and subsequent amendments).
- Do not drag the unit as the feet may be damaged or break.

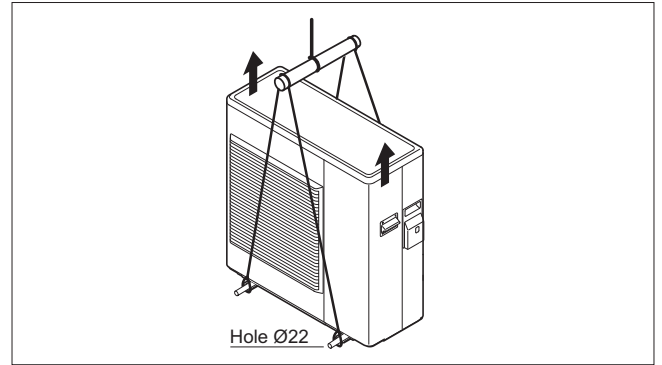
**UNIT IDENTIFICATION**

The heat pump can be identified from:

PACKAGING LABEL

Describes the product identification data

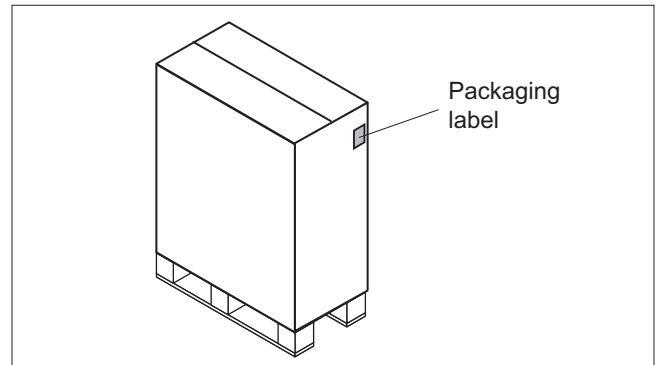
**RATING PLATE**

Describes the unit technical and performance specifications. Shows the serial number used to uniquely identify the unit. The serial number is also used to identify the unit's spare parts.

If service is required, the following information must be provided to the service centre:

Model, serial number, year of production.

⚠ Installation and maintenance operations are much more difficult if the identification plates or anything else needed to clearly identify the product are tampered with, removed or missing.

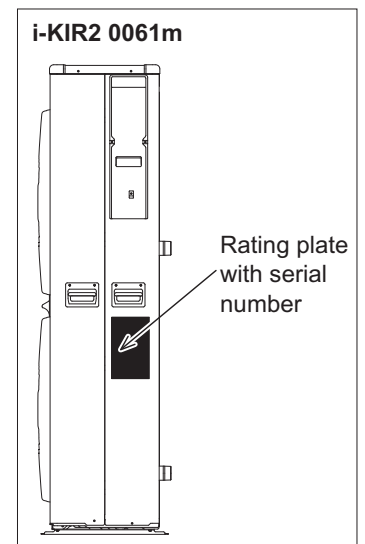
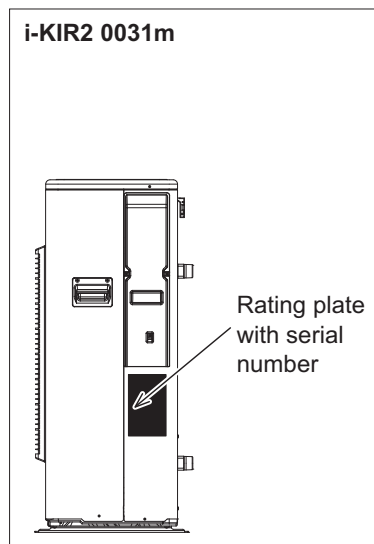
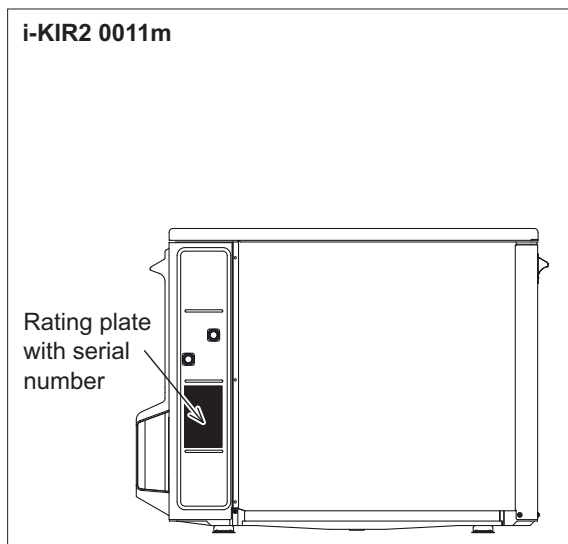
**NOMENCLATURE**

i-KIR2 MTD	0011	m
------------	------	---

Model

size

Power supply voltage:
m = 230V/50Hz/1ph

These air cooled reverse-cycle chillers with axial-flow fans operate with R410A refrigerant fluid and are suitable for outdoor installation.

The units are CE marked, as established by the EU direc-

tives, including the latest amendments, and the corresponding approximated national legislation.

They are factory tested and on site installation is limited to water and electrical connections.

i-KIR2 0011m

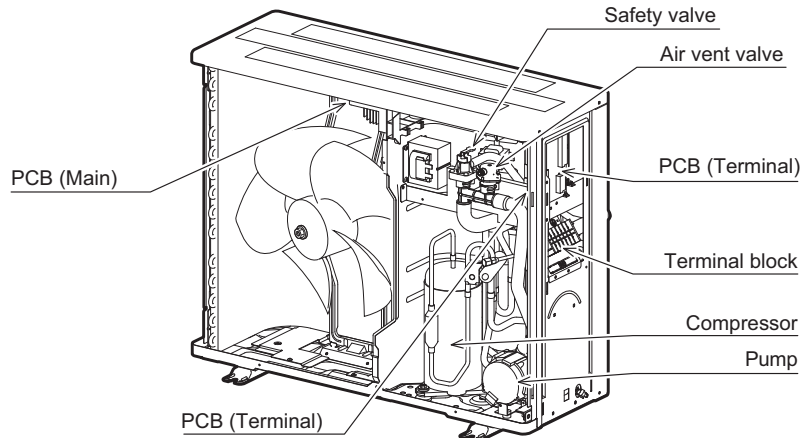

i-KIR2 0031m

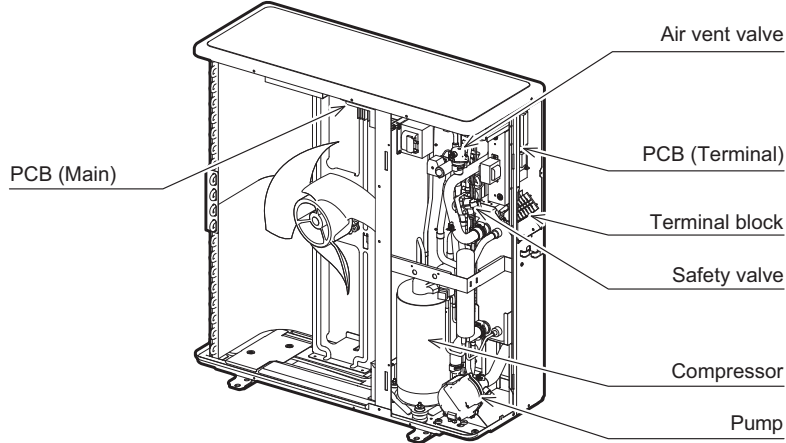

i-KIR2 0061m

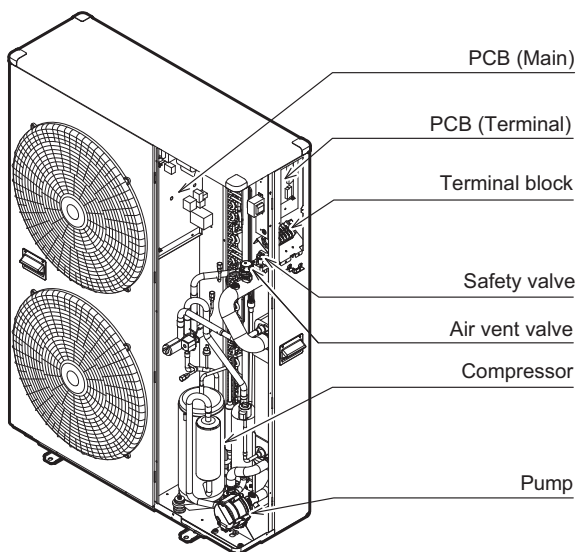

VERSIONS AVAILABLE



i-KIR2 MTD reverse-cycle air/water heat pump with DC inverter-driven compressors, domestic hot water production, axial-flow fans and hydronic unit.

The remote controller is required for correct heat pump operation, supplied separately.

i-KIR2 0011m

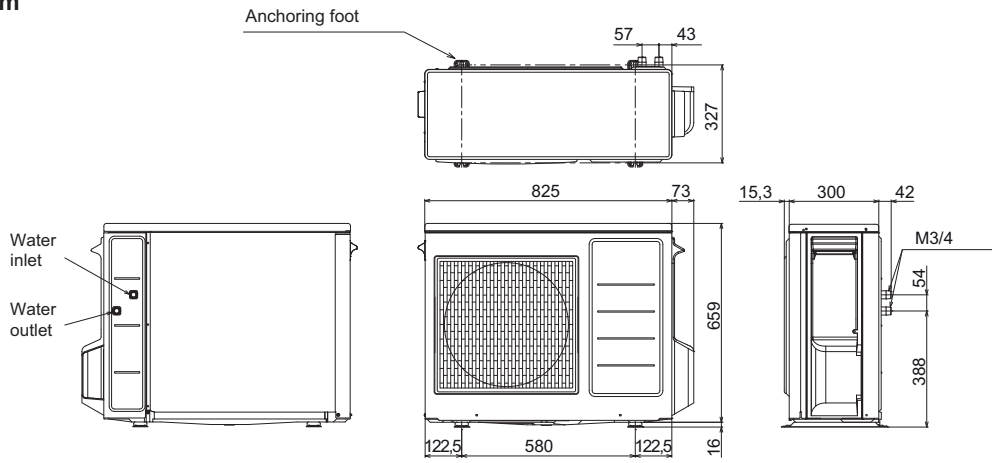

i-KIR2 0031m

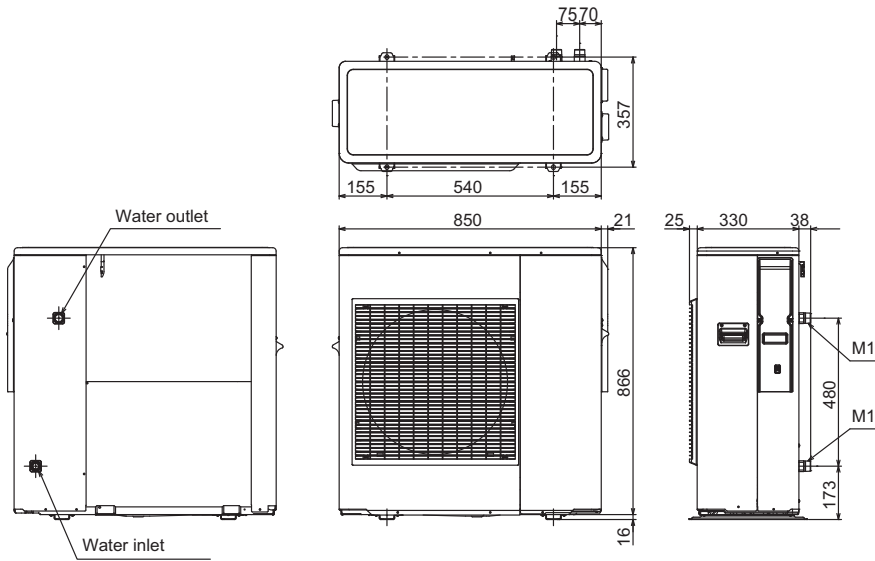

i-KIR2 0061m

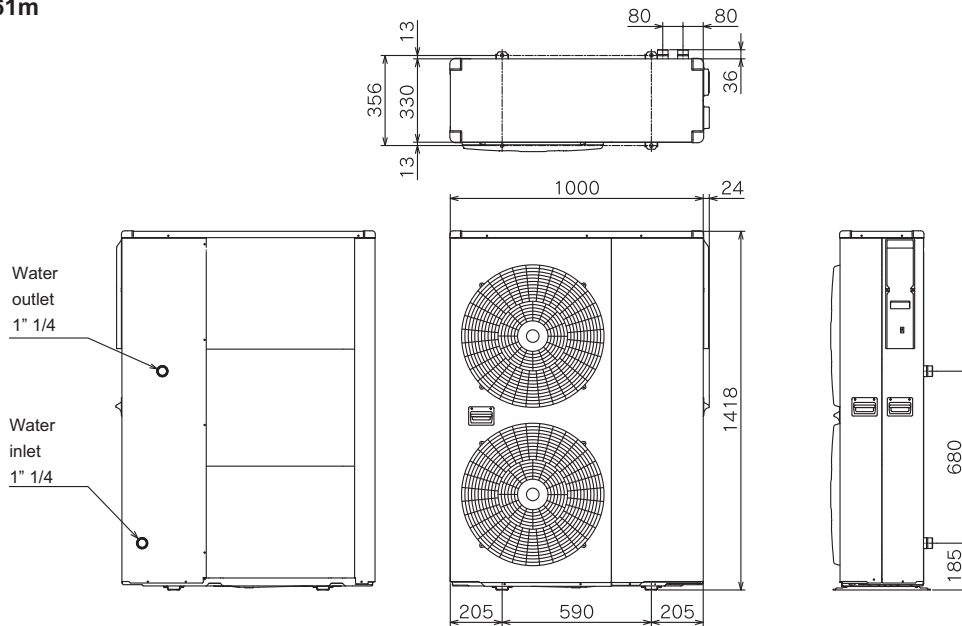

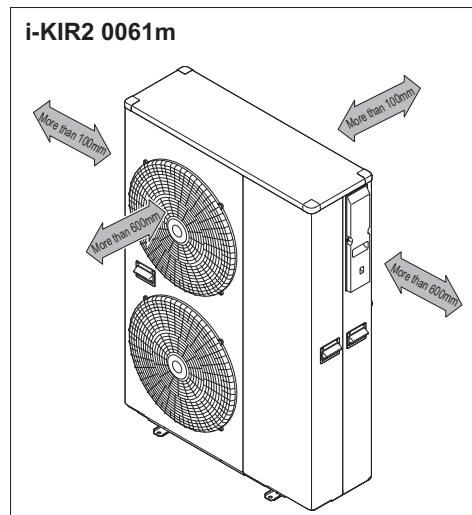
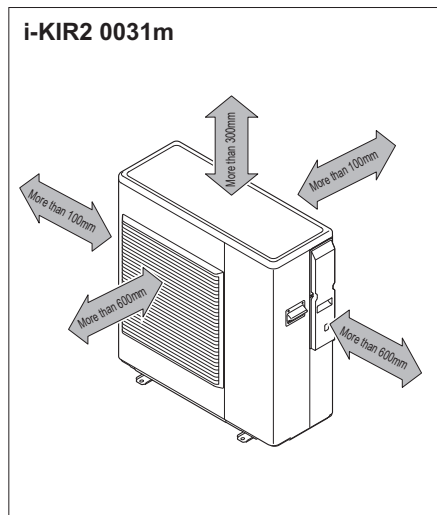
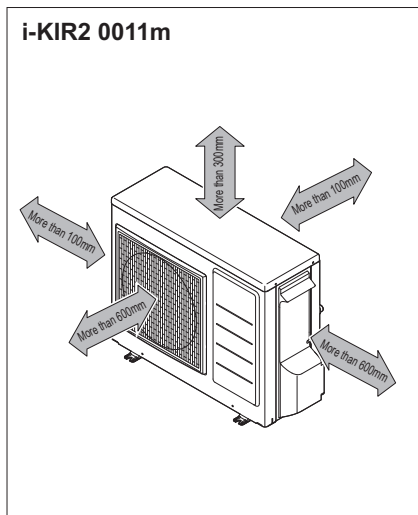

CHOICE OF INSTALLATION SITE

Before installing the unit, agree with the customer the site where it will be installed, taking the following points into consideration:

- Check that the fixing points are adequate to support the weight of the unit;
- Pay scrupulous respect to safety distances between the unit and other equipment or structures to ensure that air entering the unit and discharged by the fans is free to circulate.

- Follow the instructions shown in the chapter on “Minimum clearances” to allow room for maintenance operations.
- Unit for outdoor installation

If installing multiple units the clearances must be doubled.

POSITIONING

- Before handling the unit, check the capacity of the lift equipment used, respecting the instructions on the packaging.
- To move the unit horizontally, make appropriate use of a lift truck or similar, bearing in mind the weight distribution of the unit.
- To lift the unit, insert tubes long enough to allow positioning of the lifting slings and safety pins in the special holes in the base of the unit.
- To avoid the slings damaging the unit, place protection between the slings and the unit.
- The unit should be installed on special vibration dampers.
- See the chapter on DIMENSIONAL DRAWINGS for the support positions and the corresponding weights for the correct sizing of the vibration dampers.
- Fix the unit, making sure it is level and that there is easy access to water and electrical components.
- If the site is exposed to strong winds, fix the unit adequately using tie rods if necessary.
- In heating mode the unit produces a significant quantity of condensate, which must be suitably drained. Condensate drainage must not cause problems to objects or people.
- If the outside air temperature is less than 0°C, the condensate may freeze; in these case fit a frost protection heater on the drain line.

- For correct operation of the unit, avoid the following:
 - bstacles to air flow
 - leaves that may block the heat exchange coil
 - strong winds that stop or reinforce air flow
 - sources of heat too close to the unit, recirculation or stratification of air

The choice and installation of components is the responsibility of the installer who should follow good working practice and current legislation. Before connecting the pipes, make sure they do not contain stones, sand, rust, dross or other foreign bodies which might damage the unit.

Water connection dimensions

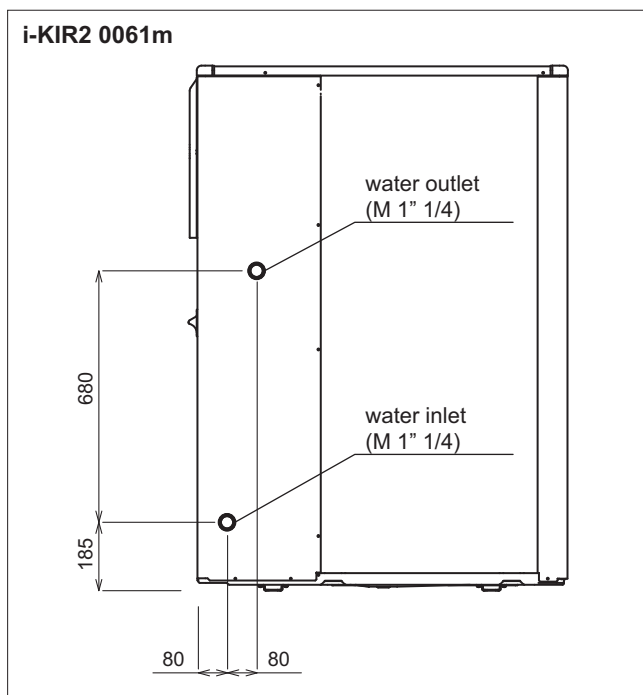
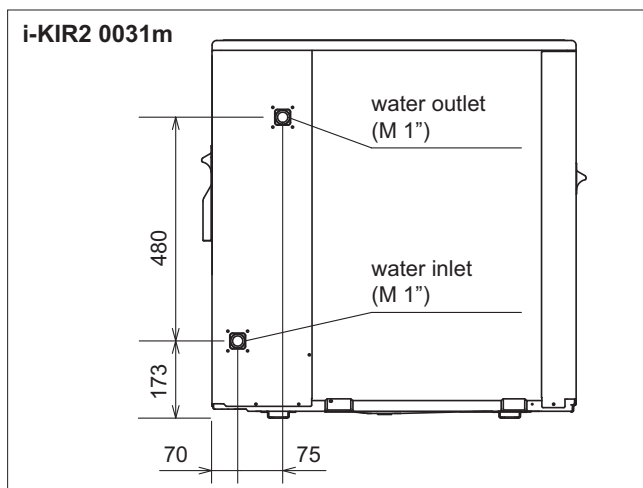
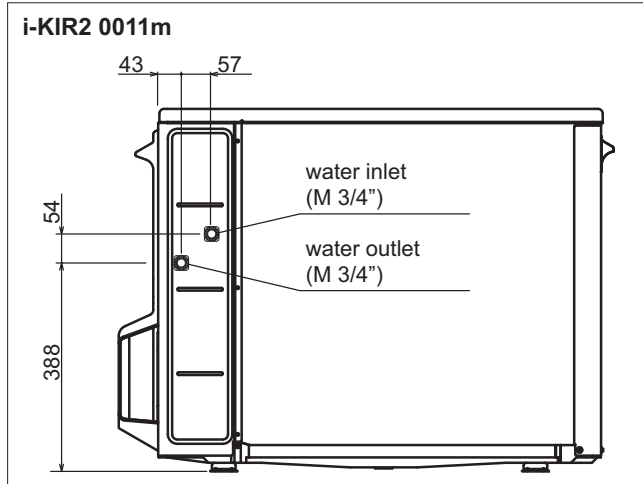

Construction of a bypass is recommended to enable the pipes to be washed through without having to disconnect the unit (see drain valves). The connection piping should be supported in such a way as to avoid it weighing on the unit.

Required components

The following components must be installed in the water circuit:

1. A flow switch (inlet). The flow switch must be calibrated by the installer to a value equal to 70% of rated flow (obligatory).
2. An intake filter must be installed as close as possible to the evaporator and positioned to allow easy access for routine maintenance.

Recommended components

The following components should be installed in the water circuit:

1. Two pressure gauges with a suitable scale (intake and outlet);
2. Two vibration damper joints (intake and outlet);
3. Two shut off valves (normal in intake and calibrating in outlet);
4. Two thermometers (intake and outlet);
5. All the pipes must be insulated with suitable material to prevent the formation of condensate and heat loss. The insulating material must be a vapour barrier. Make sure that the control and shut off devices protrude from the insulation.
6. At the lowest points in the system, install drain valves for easy emptying.
7. At the highest points in the system, install automatic or manual air vent valves.
8. Install a suitably-sized expansion vessel based on system water content and expected operating temperature.

Failure to install the flow switches will mean the heat exchangers are not protected in the event of no flow of liquid. The Manufacturer cannot be held liable for any damage to the unit and/or the system following the failure to install these devices or the filter.

The correct operation of the components that help ensure the safety of the appliance and the system should be checked regularly. Specifically, this involves cleaning the filters and checking the operation of the flow switches installed.

Water flow to the chiller unit must conform to the values shown in the section on "General Technical Data". The flow of water must be maintained constant during operation. The water content of the unit must be such as to avoid disturbing operation of the refrigerant circuits.

Risk of freezing

The unit must be prevented from freezing at outside air temperatures around 0°C.

1. use suitable percentages of antifreeze (see “Ethylene glycol solutions”)
2. protect the piping with heating sheaths,

If the unit is not operated for an extended period of time the system should be emptied, making sure no water remains in the lowest points of the system and no valves are closed that may stop water from flowing out.

It is recommended to use non-toxic food grade antifreeze, compliant with the standards in force in the countries where the unit is used, if domestic hot water production is also featured.

The antifreeze used must be corrosion inhibited and compatible with the water circuit components.

Ethylene glycol solutions

Water and ethylene glycol solutions used as a heat carrier in the place of water reduce the performance of the unit. Multiply the performance figures by the values given in the following table.

⚠ **The heat pumps** must be fitted with a filling/top-up system connected to the return line and a drain valve in the lowest part of the system.

Systems filled with antifreeze or subject to special legislative requirements must be installed with low-loss headers.

Freezing point (°C)						
	0	-5	-10	-15	-20	-25

Percentage of ethylene glycol by weight						
	0	12%	20%	28%	35%	40%
cPf	1	0,985	0,98	0,974	0,97	0,965
cQ	1	1,02	1,04	1,075	1,11	1,14
cdp	1	1,07	1,11	1,18	1,22	1,24

cPf: cooling capacity correction factor
 cQ: flow rate correction factor
 cdp: pressure drop correction factor

Water quality

⚠ The manufacturer is not liable for obstruction, breakage or noise resulting from the **failure to install filters** or vibration dampers. Particular types of **water used for filling or topping up** must be treated with appropriate treatment systems. For reference values, see the table.

P	6-8
Electrical conductivity	less than 200 mV/cm (25°C)
Chlorine ions	less than 50 ppm
Sulphuric acid ions	less than 50 ppm
Total iron	less than 0.3 ppm
Alkalinity M	less than 50 ppm
Total hardness	less than 50 ppm
Sulphur ions	none
Ammonia ions	none
Silicon ions	less than 30 ppm

Fouling factors

The performance data given refer to conditions with clean evaporator plates (fouling factor = 1). For different fouling factors, multiply the figures in the performance tables by the coefficient given in the following table.

Fouling factors (m ² °C/W)	Evaporator		
	f1	fk1	fx1
4,4 x 10 ⁻⁵	-	-	-
0,86 x 10 ⁻⁴	0,96	0,99	0,99
1,72 x 10 ⁻⁴	0,93	0,98	0,98

f1: capacity correction factor
 fk1: compressor power input correction factor
 fx1: total power input correction factor

System circuit connection

- Use a flat gasket to ensure tightness
- Connect the flexible joints to the probe socket fittings installed on the heat pump
- Connect the system pipes to the flexible joints
- Use two spanners to tighten the water connections
- Install the filter on the system return pipe

Water content in the system

The minimum system water content must be guaranteed at all times.

Size		0011	0031	0061
Minimum water content	l	26	26	60

Safety valve calibration

Size		0011	0031	0061
Safety valve	bar	3	3	3

Utility water circuit connection diagram

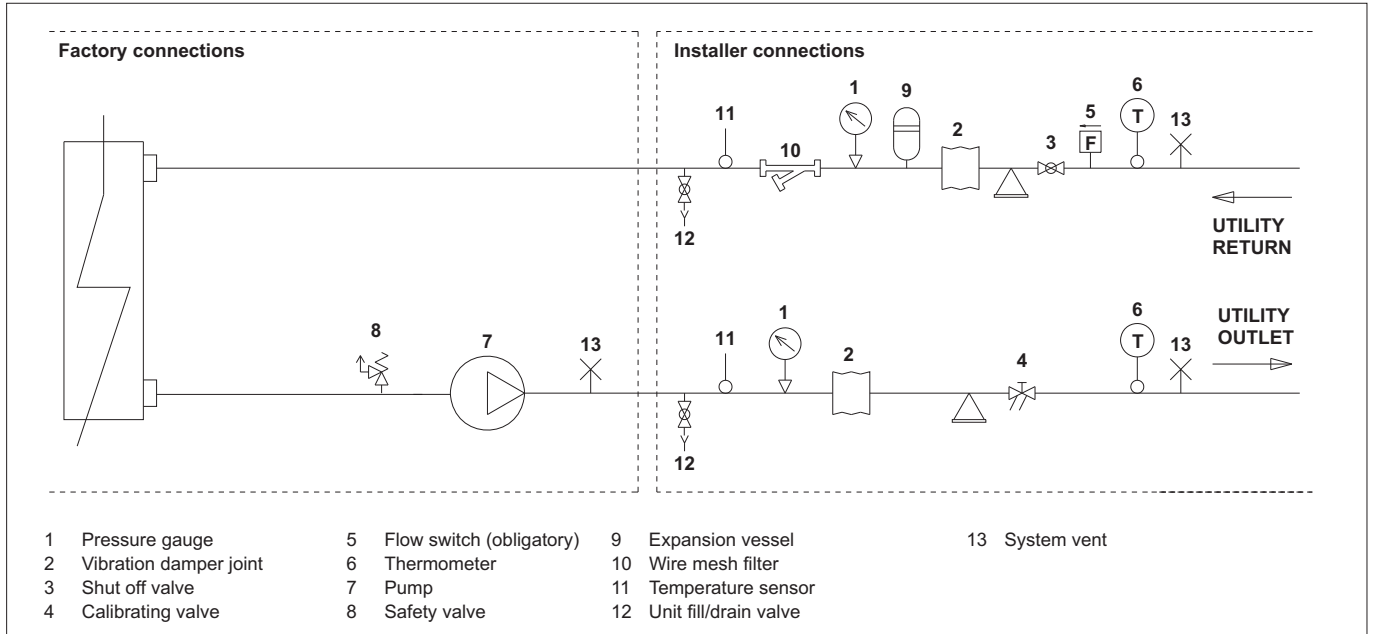

Condensate drain

The unit is fitted with condensate pan; this must be connected to a drain system to take away the water that forms, see the drawing.

In heating mode the unit produces a significant quantity of condensate, which must be suitably drained.

Proceed as follows:

- Connect the unit condensate drain
- Make sure the drain hose has a incline of at least 2 cm/m, without obstructions or choking.
- Connect the condensate drain hose to a rainwater drain. Do not connect to the sewage system as odours may be sucked up if the water in the drain trap evaporates.
- After connecting, check correct drainage of the condensate by pouring water into the pan.
- If necessary, suitably insulate the condensate drain hose.
- Condensate drainage must not cause problems to objects or people.

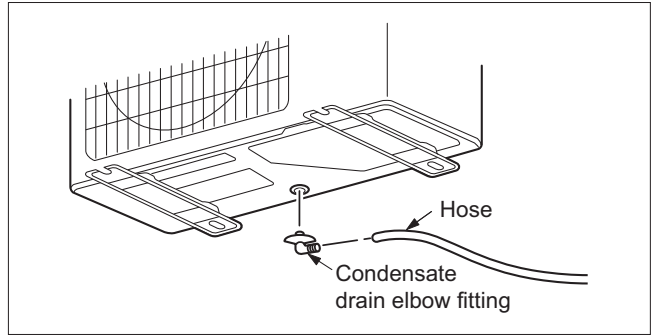

If the outside air temperature is less than 0°C, the condensate drained from the collection pan may freeze. The unit must be supported on a suitable structure or brackets to keep it off the ground, with a frost protection heater fitted on the drain line.

FILLING THE SYSTEM

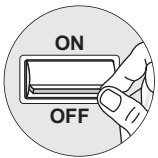

- Before starting to fill, place the unit mains switch QF1 in the OFF position.
- Before filling, check that the system drain valve is **closed**.
- Open all system and terminal air vents.
- Open system shut off valves.
- Start filling by slowly opening the system water fill valve outside the unit.
- When water begins to leak out of the terminal air vent valves, close them and continue filling until the pressure gauge indicates a pressure of 1.5 bar.

⚠ The system must be filled to a pressure of between 1 and 2 bars.

It is recommended that this operation be repeated after the unit has been operating for a number of hours. The pressure in the system should be checked regularly and if it drops below 1 bar, the water content should be topped-up.

Check the tightness of the joints.

EMPTYING THE SYSTEM

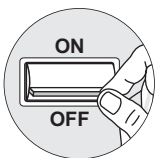

- Before starting to empty, place switch QF1 in the "OFF" position
- Make sure the system fill/top-up water valve is closed.
- Open the drain valve outside the unit and all the installation and terminal air vent valves..

⚠ If the fluid in the circuit contains antifreeze, it should not be allowed to drain freely, as it is pollutant.

It should be collected for possible reuse. When draining after heat pump operation, take care as the water may be hot (up to 50°).

The heat pumps must be installed downstream of a group-operated switch (QF1, see wiring diagram) on the mains power supply line, as required by the standards in force in the country where the unit is installed. This switch must be installed by authorised personnel.

For all electrical work, refer to the electrical wiring diagrams in this manual.

It is also recommended to check that:

- The characteristics of the mains electricity supply are adequate for the power ratings indicated in the electrical specifications below, also bearing in mind the possible use of other equipment at the same time.

⚠ Power to the unit must be turned on only after installation work (plumbing and electrical) has been completed.

All electrical connections must be carried out by qualified personnel in accordance with legislation in force in the country concerned

Respect instructions for connecting phase, neutral and earth conductors..

The power line should be fitted upstream with a suitable device to protect against short-circuits and leakage to earth, isolating the installation from other equipment.

⚠ Voltage must be within a tolerance of $\pm 10\%$ of the rated power supply voltage for the unit. If these parameters are not respected, contact the electricity supply company.

For electrical connections, use double insulation cable in conformity with legislation in force in the country concerned.

⚠ A thermal overload switch and a lockable mains disconnect switch, in compliance with the CEI-EN standards (contact opening of at least 3mm), with adequate switching and residual current protection capacity based on the electrical data table shown below, must be installed as near as possible to the appliance.

⚠ An efficient earth connection is obligatory.

The manufacturer cannot be held liable for any damage caused by the failure to correctly earth the unit.

The maximum impedance allowed by the unit (Z_{max}) is 0.354Ω for model i-KIR2 0031 and 0.33Ω for model i-KIR2 0061.

The unit can be connected if the mains power supply impedance is $\leq 0.354\Omega$ for model i-KIR2 0031 and $\leq 0.33\Omega$ for model i-KIR2 0061.

⊖ Do not use water pipes to earth the unit.

⚠ WARNING

- The power supply current rating must be equal to the sum of the current drawn by the air-water heat pump and the current drawn by any other electrical appliances.

If the contracted current rating is insufficient, make sure this is adapted accordingly.

- If the voltage is low and the air-water heat pump has difficulty starting, contact your electricity supplier to have the voltage increased.

How to connect the cables to the terminal

Pay attention during wiring operations

- When stripping a main cable, always use special tools such as wire strippers. If no specific tool is available, strip the wires carefully using a knife, etc.

- (1) Use crimp-on terminals with insulating sleeves as illustrated in the figure below for connecting the wires to the terminal block.
- (2) Securely fasten the crimp-on terminals to the wires using a special tool, so that the wires don't come free.

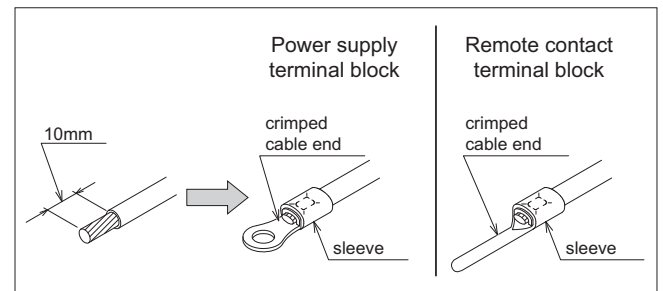

- (3) Use the cables specified, connect them securely and in such a way that they don't exert pressure on the terminals.
- (4) Use a suitable screwdriver to tighten the screws on the terminals. Don't use damaged screwdrivers, otherwise the screw heads may also be damaged and the screws cannot be tightened correctly.
- (5) Don't over-tighten the screws on the terminals, otherwise they may break.

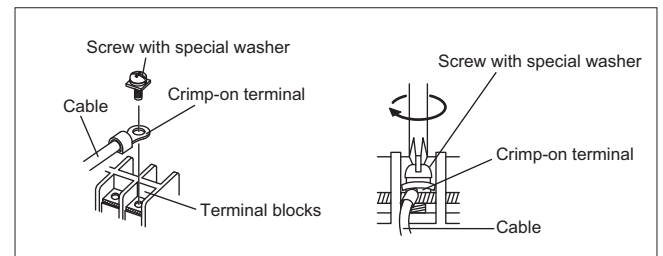

Make sure a dedicated power supply with residual current circuit breaker is used.

In accordance with the following designations, use cables with wire sizes as described in the table below.

The power cable must be approved in compliance with IEC 60245 IEC57(H05RN-F)

As concerns all-pole disconnection, the product requires a hard-wired overcurrent protection device in compliance with wiring standards and relevant national requirements. The classification of this device must be suitable for the product specifications.

Size	Power supply cable (mm ²)		Switch rating (A)
	MAX.	MIN.	
0011m	2,0	1,5	16
0031m	4,0	3,5	20
0061m	5,5	4,0	32

Strip the end of the connection cables according to the measurements shown in the following drawing.

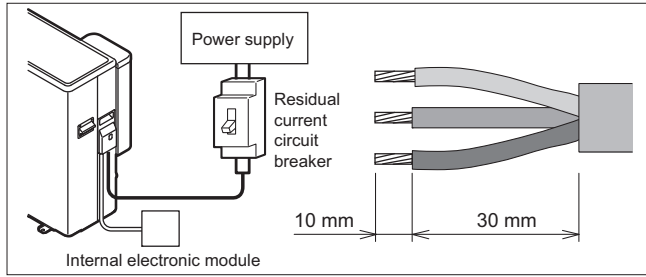

⚠ WARNING

The connection cable must be stripped along a 10 mm section. If this section is shorter, contact may be defective. Longer sections may cause short-circuits.

- Use a residual current circuit breaker with a gap of around 3 mm between contacts.
- Poor wiring may not only cause malfunctions but also damage to the PC board.
- Suitably tighten all the screws.
- To check these are tight, tug the cable lightly.

Electrical data at maximum conditions allowed (full load)

Model	Power supply	Total			Fan		Pump		Main board fuses (250V)							Remote contact board fuses (250V)
		F.L.A. (A)	F.L.I. (kW)	S.A. (A)	F.L.I. (kW)	F.L.I. (kW)	CF1 (A)	CF2 (A)	CF3 (A)	CF4 (A)	CF5 (A)	CF6 (A)	CF7 (A)	CF1 (A)		
i-KIR2	(V-ph-Hz)	(A)	(kW)	(A)	(kW)	(kW)	(A)	(A)	(A)	(A)	(A)	(A)	(A)	(A)		
0011m	230-1-50	11,2	2,55	7,8	0,30	0,12	15 (6x30)	T3.15 (5x20)	3 (4.6x16)	3 (4.6x16)	N/A	15 (6x30)	N/A	T10 (5x20)		
0031m	230-1-50	17,5	3,98	10,2	0,10	0,17	25 (6x30)	T3.15 (5x20)	3 (4.6x16)	3 (4.6x16)	N/A	25 (6x30)	T3.15 (5x20)	T10 (5x20)		
0061m	230-1-50	25,3	5,76	17,8	0,20	0,17	30 (6x30)	T5 (5x20)	3 (5x20)	N/A	3 (5x20)	T3.15 (5x20)	T3.15 (5x20)	T10 (5x20)		

Maximum values for sizing the protection switches and power supply cables.

F.L.A. Maximum current input

F.L.I. Maximum power input

S.A. Start-up current

WIRING DIAGRAMS

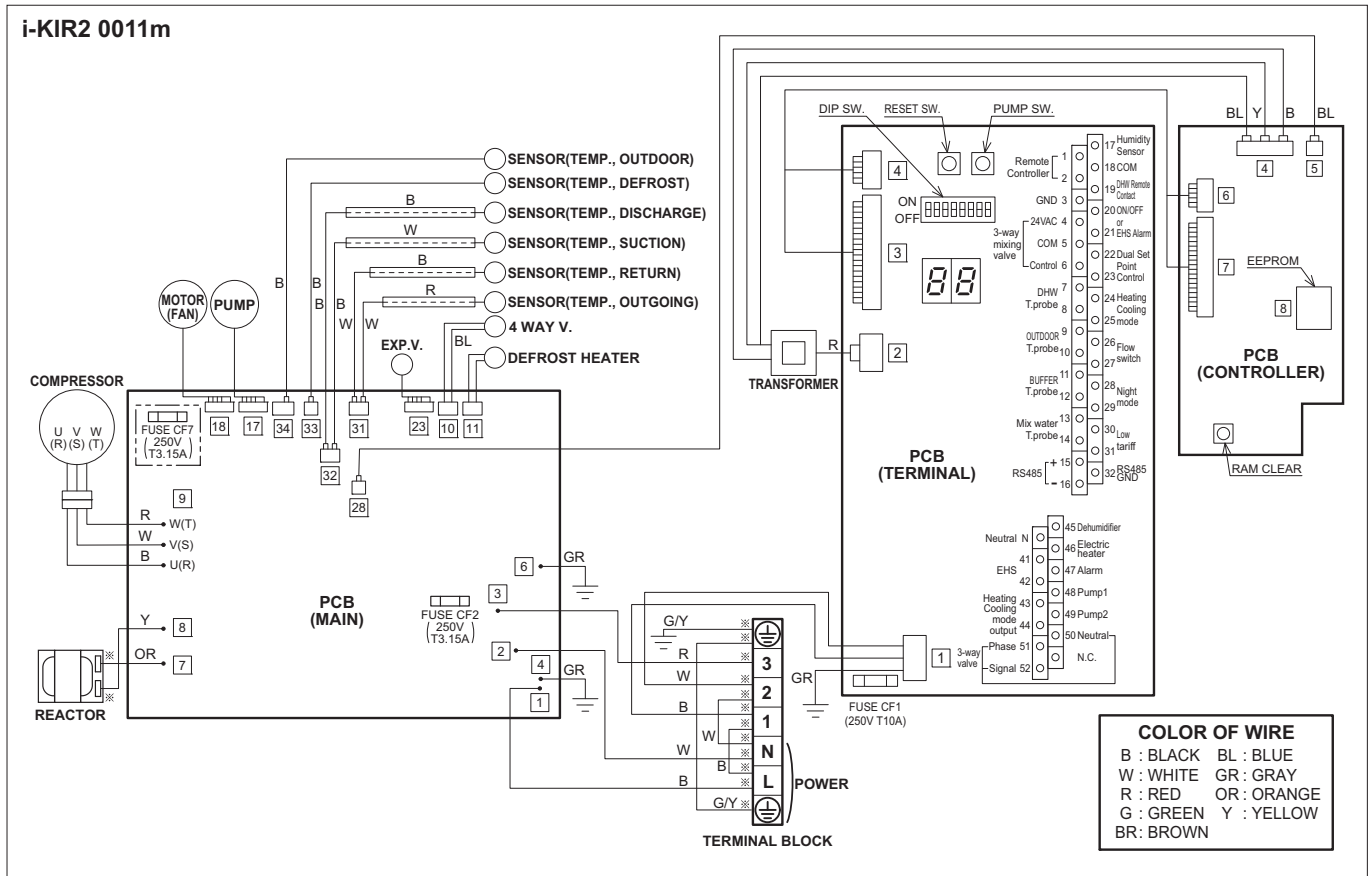

i-KIR2 0031m

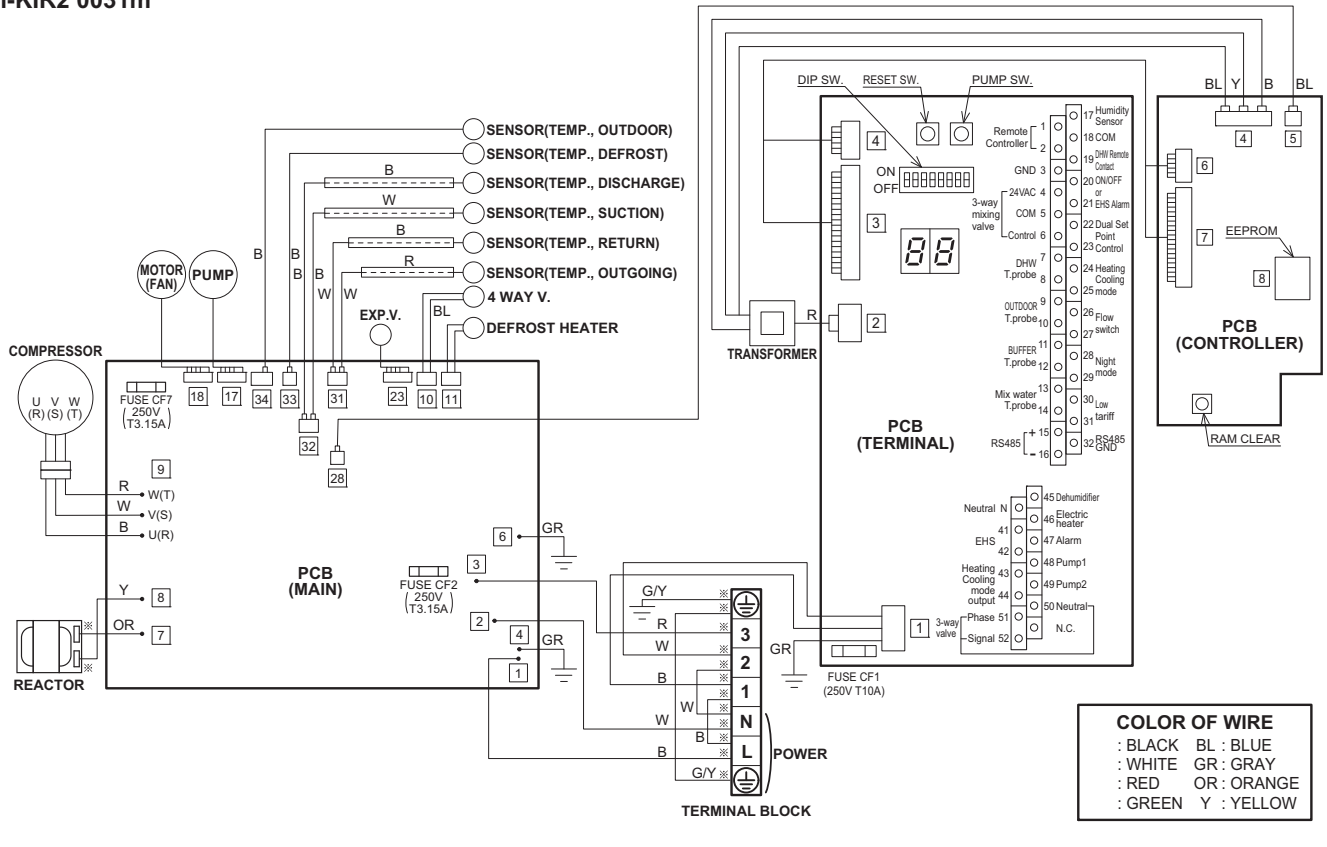

i-KIR2 0061m

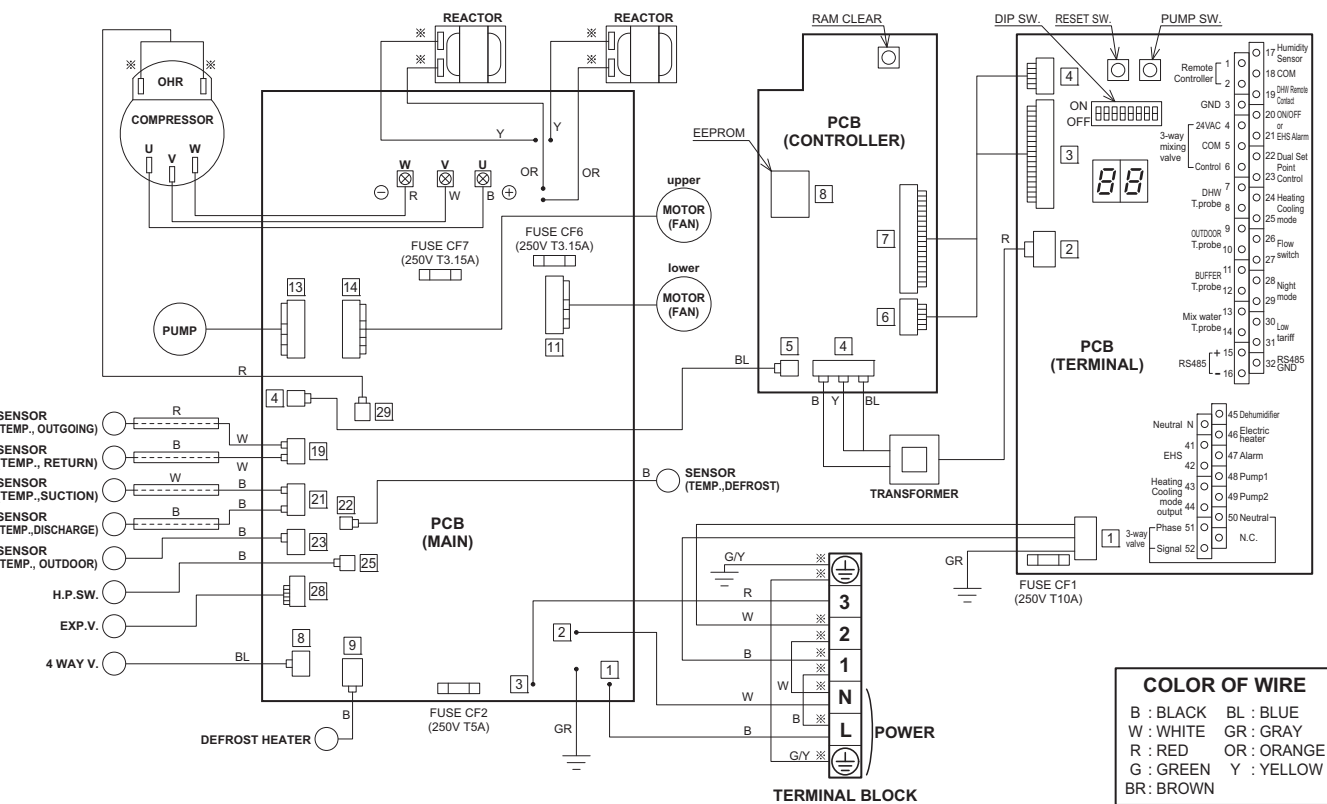

Remote contact terminal board

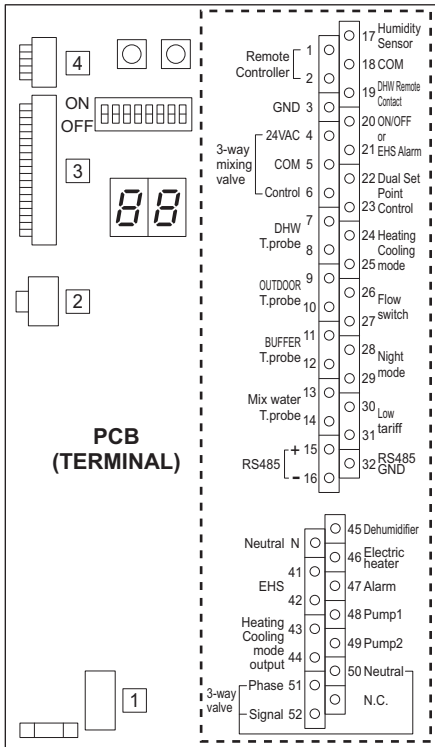

Table of analogue and digital inputs/outputs

Serial connections

Terminal	Function	Analogue Input	Digital Input
1 - 2 - 3	Remote Controller	1=S1, 2= S2, 3= GND	Wires length is maximum 100m with Ø1mm shielded cables.

Analogue/Digital INPUTS

Terminal	Function	Analogue Input	Digital Input
7 - 8	DHW temperature probe (option)		
9 - 10	Outdoor air temperature probe (option)		
11 - 12	BUFFER temperature probe (option)		
13 - 14	Mix Water temperature probe (option)		
17 - 18	Humidity Sensor (option)	0-10V DC	
18 - 19	DHW Remote contact		Voltage free contact 12V10mA
20 - 21	Configurable input: -ON/OFF remote contact -EHS Alarm		Voltage free contact 12V10mA
22 - 23	Dual Set Point Control		Voltage free contact 12V10mA
24 - 25	Heating/Cooling mode remote contact		Voltage free contact 12V10mA
26 - 27	Flow switch		Voltage free contact 12V10mA
28 - 29	Night mode		Voltage free contact 12V10mA
30 - 31	Low tariff		Voltage free contact 12V10mA

Analogue/Digital OUTPUTS

Terminal	Function	Analogue Output	Digital Output
4 - 5 - 6	3 -way mixing valve	6=0-10V DC (control)	4-5 =24V AC
N	Neutral		1ph 230V, 1ANeutral
41 - 42	EHS (External heat source for space heating)		1ph 230V, 1A (in case of coil relay 40mA)
43 - 44	Heating / Cooling mode output		1ph 230V, 1A (in case of coil relay 40mA)
45	Dehumidifier		1ph 230V, 1A (in case of coil relay 40mA)
46	Electric heater for DHW or Backup Heater		1ph 230V, 1A (in case of coil relay 40mA)
47	Alarm (Configurable output) - Alarm - Ambient temperature reached		1ph 230V, 1A (in case of coil relay 40mA)
48	Pump1 (1st Additional Water Pump)		1ph 230V, 1A (in case of coil relay 40mA)
49	Pump2 (2nd Additional water pump)		1ph 230V, 1A (in case of coil relay 40mA)
50 - 51-52	DHW 3-way valve		1ph 230V, 1A 50= Neutral , 51 =Phase 52 =Signal

- Before connecting the unit to the mains power supply, make sure that the mains power supply switch QF1 is open ("OFF").

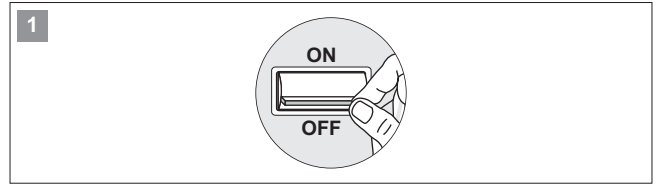

- Remove the protective cover from the heat pump terminal block by unscrewing the fastening screw.

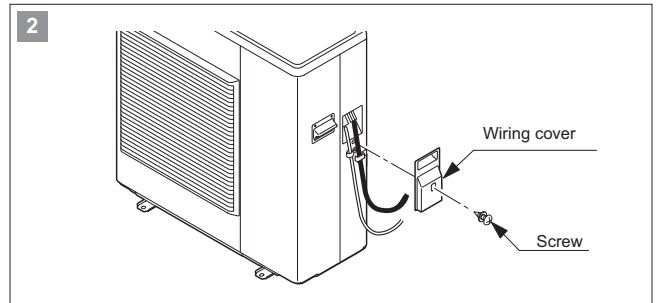

- Connect the power supply to the heat pump terminals as shown in drawing 3.
- Make sure that all the protective devices removed to make the electrical connections have been repositioned before powering up the unit.
- Reposition the wiring cover on the heat pump.
- For all mains power connections, move the main switch QF1 (outside the appliance) to "ON".

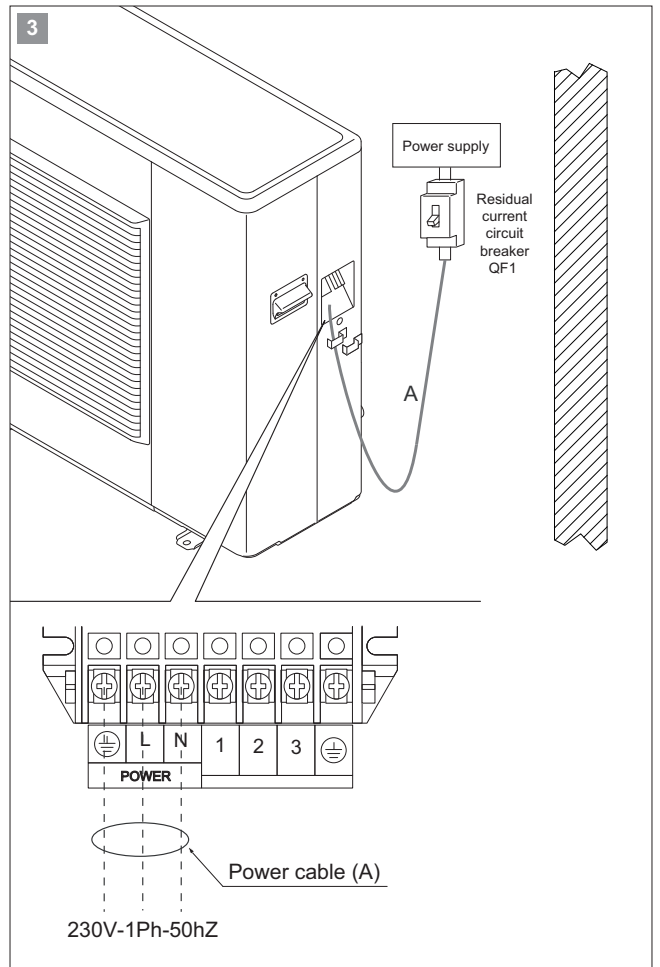

Below is a list of the electrical connections that can be performed by the installer using the terminals on the remote contact board. The maximum length of probe cables is 100 m for 1 mm² cables, and 50 m for 0.5 mm² cables.

Outside air temperature probe connection (Outdoor T.probe)

The outside air temperature probe, supplied as an accessory, is used in cases where the air temperature probe on the unit cannot provide a correct reading of the outside air temperature.

The outside air probe allows the system water temperature set point to be compensated during heating or cooling operation.

Installation instructions

The outside air probe must be installed:

- outside of the home
- not in direct sunlight, away from flue gas discharges, air outlets, or doors and windows.
- on a perimeter wall facing north/north-west
- at a minimum height of 2.5 metres above the ground or at most half way up the house.

Mounting method:

- Open the cover of the sensor by unscrewing the 4 screws.
- Attach a probe to the wall and the correct position as described above.
- For the electrical connections see "Connection diagram".
- Re-place the cover of the sensor.

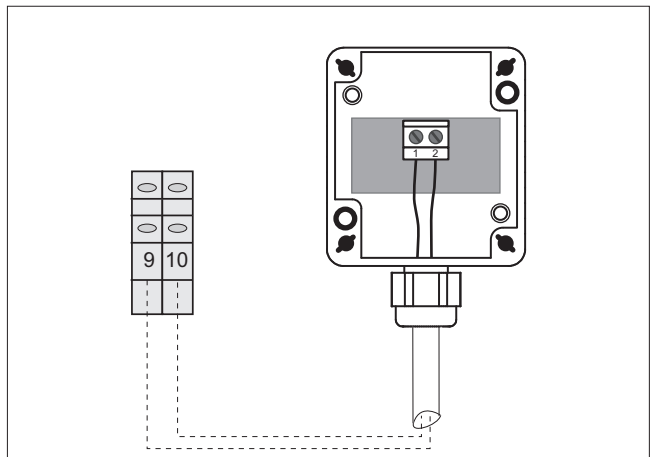
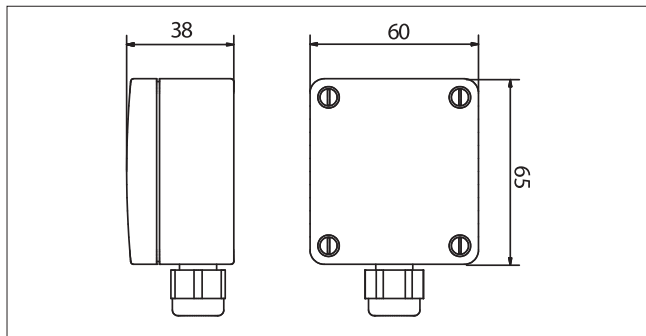
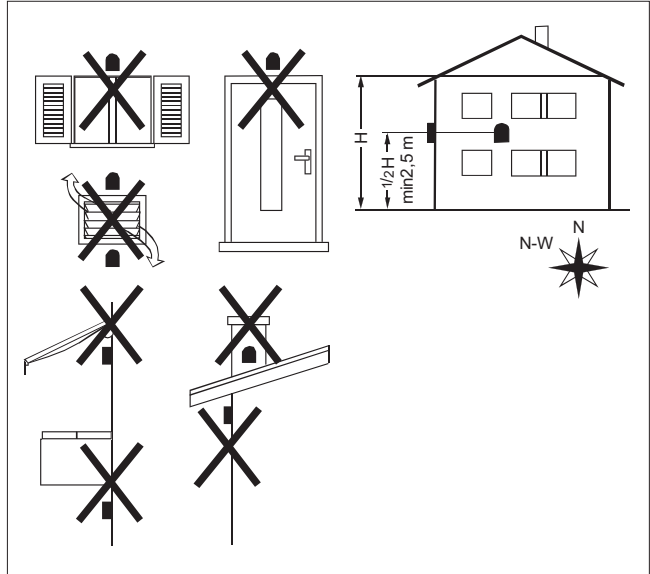

The remote outside air temperature probe must be enabled by setting the following parameter.

Description	Menu	Parameter no.	Default	Value to be set	UOM
Enable remote outside air temperature probe 0 = Disabled 1 = Enabled	51	09	0	1	-

Technical data	
Sensing element	NTC 10Kohm ± 1% (25°C)
Degree of protection	IP65
Perm. ambient / carriage temperature	-50°C...+100°C
Measuring range	-50°C...+100°C
Materials	PA 15% GK, Colour RAL 9010

Remote controller connection (Remote Controller)

Installation instructions

The remote controller is fitted with an air temperature sensor for controlling room temperature. In this case, the remote controller must be installed in a reference position, as described below:

- around 1.5 metres from the floor, in a part of the room that allows the sensor to accurately measure the room temperature;
- away from cold air flows, sunlight or other sources of heat.
- leave enough space above the room controller to allow assembly and removal where necessary.
- If the room controller is removed from its base, it disconnects from the power supply and consequently is no longer operating.

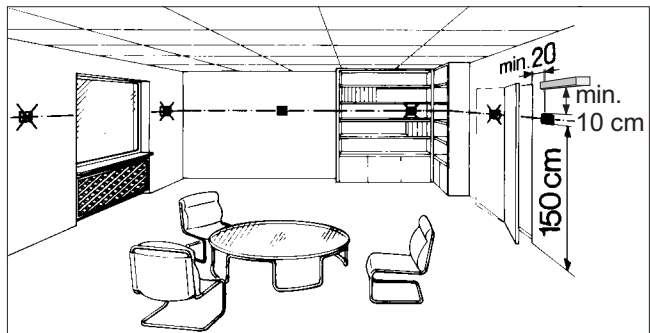

If the heat pump is not used for room temperature control, the remote controller can also be installed in an equipment room, as long as this is protected against the weather.

Installation procedure

Assembly

- Detach the support **A** from the remote controller **B**.
- Fasten the support **A** to the wall using the holes provided.
- Make the electrical connections as shown on the wiring diagram.
- Attach the remote controller **A** to the tabs **C** on the support **B**.

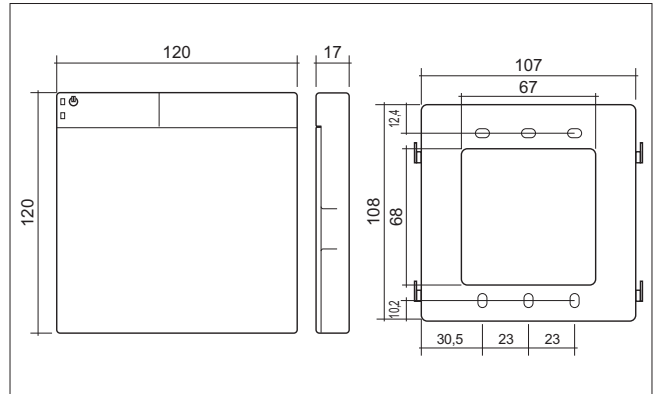
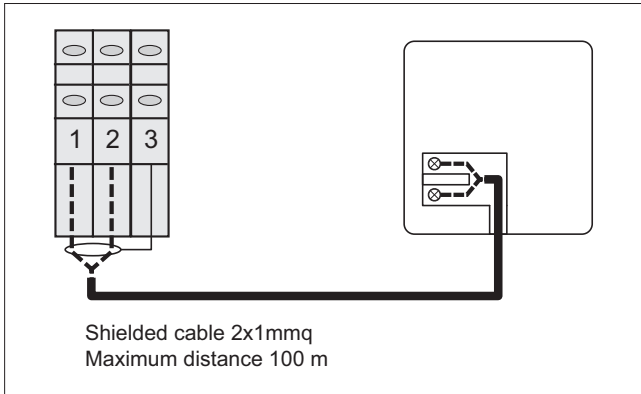
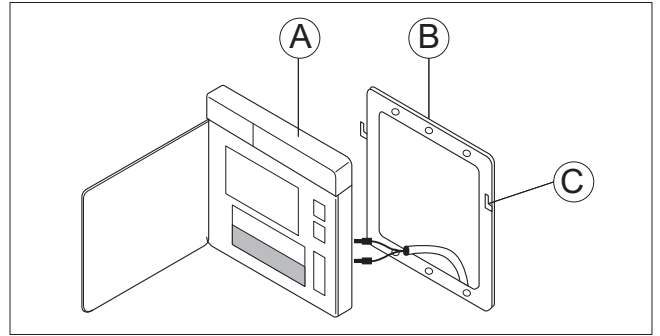

3-way valve for domestic hot water production (3-way valve)

The 3-way valve installed outside of the unit deviates the flow of hot water produced by the unit to the DHW storage tank. During domestic hot water production, the cooling/heating demand is not satisfied. Wire the three-way valve supplied as an accessory by Manufacturer following the instructions shown in the figure.

The valve is also fitted with a limit switch. The limit switch contact is either closed or open based on the position of the valve.

Limit switch (red and green wires):
Auxiliary contact closed = Valve open
Auxiliary contact open = Valve closed

If not supplied by Manufacturer, the 3-way valve for domestic hot water production should have the following characteristics:

- Voltage 230V AC, 50/60 Hz
 - Opening/closing time 10s.
 - Delta P 500 kPa
 - Fluid temperature 0°C to 90°C
- Use three-way valves with pressure drop below 20kPa.

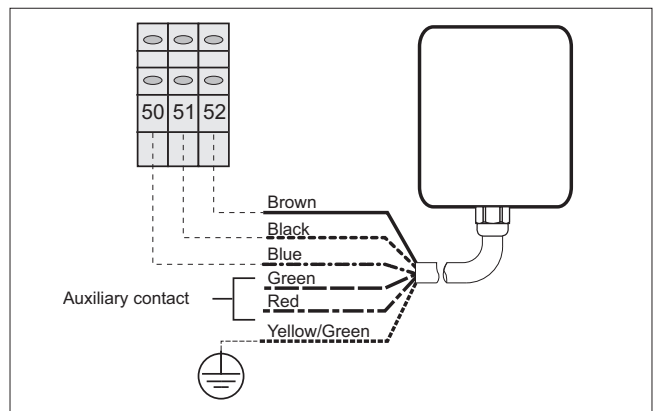

If three-way valves with a travel time greater than 10 seconds are used, modify the setting of parameter 4511.

Description	Parameter no.	Default	Value to be set	UOM
Three-way valve travel time for domestic hot water production	4511	12	Set the travel time for valves not supplied by the heat pump manufacturer	sec.

DHW storage electric heater (DHW T.Probe)

Domestic hot water temperature inside the storage tank is measured using the DHW T. Probe, supplied as an accessory.

Description	Menu	Parameter no.	Default	Value to be set	UOM
DHW storage tank water temperature probe (DHW T. probe): 0 = Disabled 1 = Enabled	51	07	0	1	-

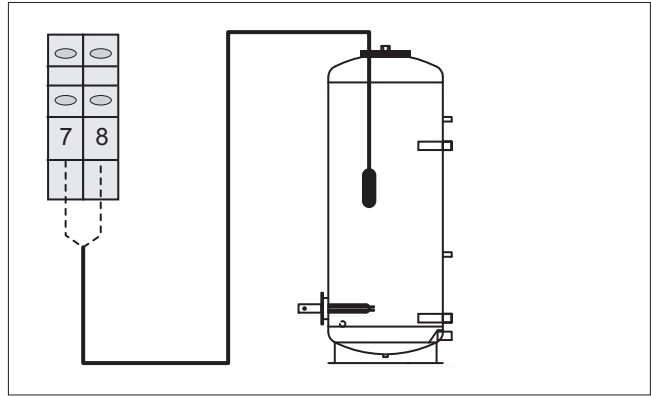

Water storage tank temperature probe (Buffer T. probe)

The water storage tank temperature probe (Buffer T. probe), supplied as an accessory, must be enabled by setting parameter 5111. The heat pump works so as to reach the water temperature set point based on the value measured by the "Buffer T. probe".

The storage tank probe is required if needing to manage an outlet electric heater (Backup heater) or an additional system heat source (EHS).

Description	Menu	Parameter no.	Default	Value to be set	UOM
Water storage tank temperature probe (Buffer T. probe): 0 = Disabled 1 = Enabled	51	11	0	1	-

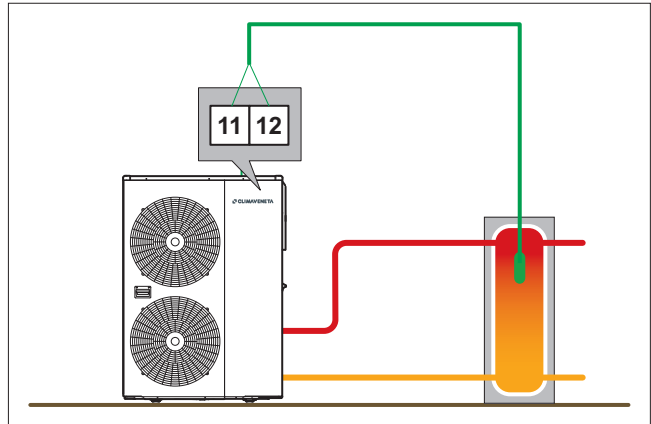

Low temperature system management (zone 1)

The controller can manage a low temperature zone for radiant panel systems.

The unit can be configured to manage a modulating mixing valve with 0-10 V control, a circulator pump and a manifold temperature probe.

Description	Menu	Parameter no.	Default	Value to be set	UOM
Mixing valve water temperature probe for low temperature zone 1 (Mix water T. probe): 0 = Disabled 1 = Enabled	51	13	0	1	-
Enable zone 1 pump 0 = Disabled 1 = Zone 1 pump enabled	51	48	0	1	-
Enable mixing valve: 0 = Disabled 1 = Enabled	51	04	0	1	-
Mixing valve integral time	45	02	60		10sec.
Maximum radiant system water temperature limit	45	03	50		0,5°C

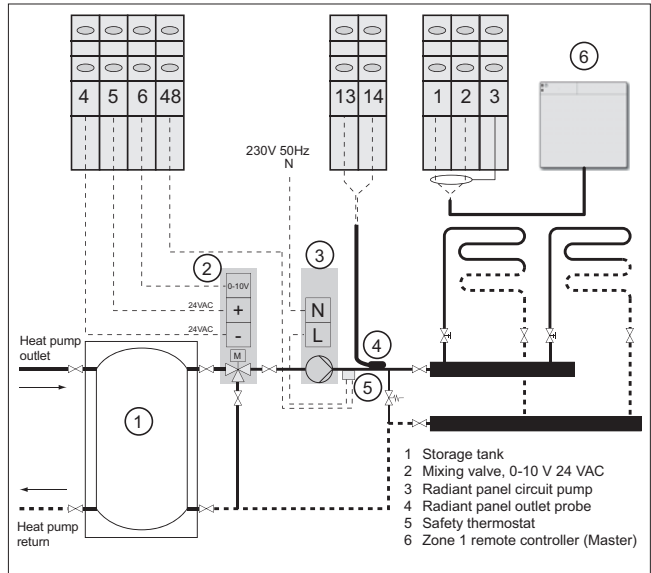

The operating modes are shown in the chapter on "Control and operating characteristics".

Zone 1 dehumidifier management (Humidity Sensor and Dehumidifier)

The controller can manage a dehumidifier for controlling the humidity in radiant panel systems when operating in cooling mode.

The unit can be connected to a humidity sensor with 0-10 V output and a dehumidifier.

Description	Menu	Parameter no.	Default	Value to be set	UOM
Enable humidity probe 0 = Disabled 1 = Enabled	51	17	0	1	-
Enable dehumidifier contact 0 = Disabled 1 = Zone 1 pump enabled	51	45	0	1	-

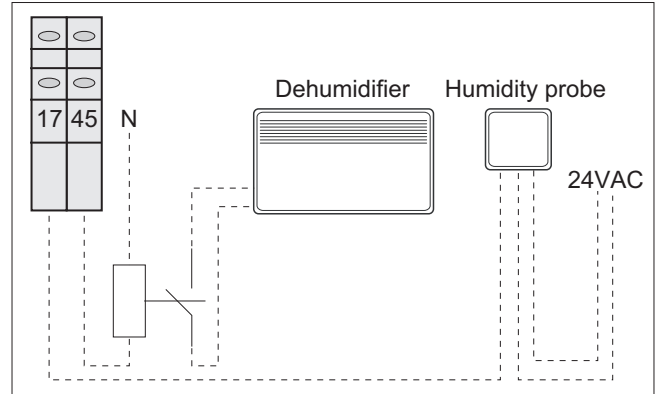

High temperature system management (zone 2)

The controller can manage a second zone (zone 2), usually with a water temperature set point that is higher in heating mode and lower in cooling mode compared to zone 1.

The unit can be configured to manage a pump or motorised shut-off valve.

Description	Menu	Parameter no.	Default	Value to be set	UOM
Enable zone 2 pump 0 = Disabled 1 = Zone 2 pump enabled	51	49	0	1	-

The operating modes are shown in the chapter on “Control and operating characteristics”.

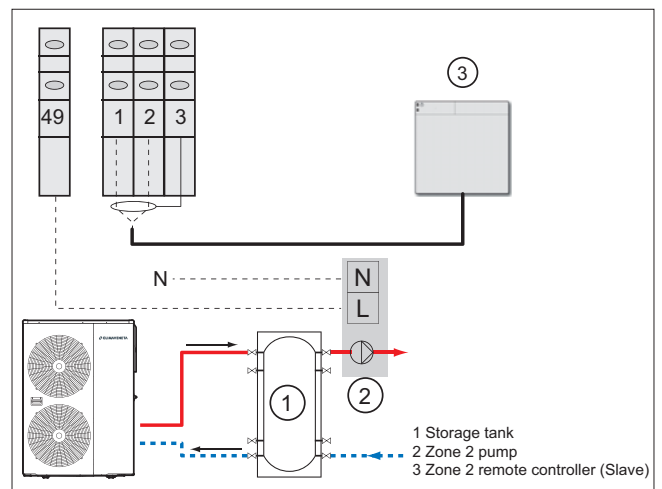

Configurable contact (ON/OFF or EHS alarm)

The contact can be configured to manage the following operating modes:

- Remote ON/OFF contact
- Boiler backup contact (EHS alarm)

Remote ON/OFF contact

This is used to switch the unit on or off via a remote contact, for example a timer or room thermostat.

The remote off signal stops the compressor, fan and pumps, while all the frost protection functions remain active.

The table shows heat pump operating status based on the signal from the ON/OFF button on the remote controller and the remote contact.

Remote controller connected and enabled			Remote controller not enabled	
ON/OFF from remote controller	ON/OFF from remote contact	Heat pump operating status	ON/OFF from remote contact	Heat pump operating status
ON	ON	ON	ON	ON
ON	OFF	OFF	OFF	OFF
OFF	ON	OFF		
OFF	OFF	OFF		

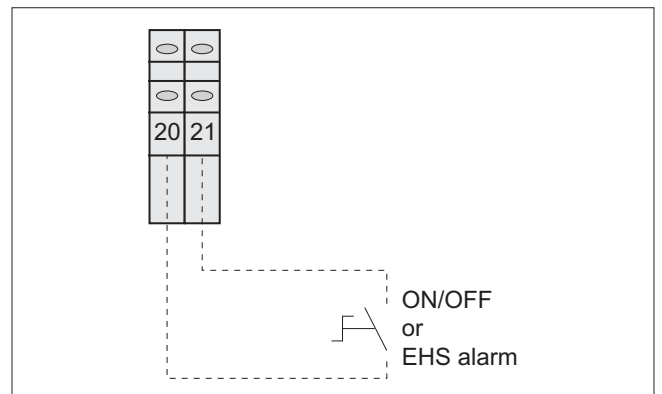

Suitably set the following parameter in order to configure the contact as remote ON/OFF:

Description	Menu	Parameter no.	Default	Value to be set	UOM
Enable contact as: 0 = Disabled 1 = Remote ON/OFF contact 2 = Boiler backup (EHS alarm)	51	20	0	1	-

Contact closed = Heat pump ON
Contact open = Heat pump OFF

Boiler backup contact (EHS alarm)

If the boiler shuts down, the heat pump is activated in its place, momentarily overriding the operating logic (supplementary/replacement) so as to ensure heating or domestic hot water is provided in the building, depending on the set priority.

Boiler shutdown is signalled to the heat pump via the alarm contact (EHS alarm). When the boiler contact is closed due to an active alarm, the heat pump is started (compressor ON), even if its configuration would otherwise keep the unit in standby.

The heat pump will provide heating or DHW in the building, within the operating limits described in the chapter on "Operating limits".

Suitably set the following parameter to configure the contact as boiler backup:

Description	Menu	Parameter no.	Default	Value to be set	UOM
Enable contact as: 0 = Disabled 1 = Remote ON/OFF contact 2 = Boiler backup (EHS alarm)	51	20	0	2	-

DHW remote contact

Allows domestic hot water production to be enabled or disabled via a remote contact.

The table shows heat pump operating status based on the mode selected on the remote controller, for domestic hot water production, and the status of the DHW remote contact.

DHW operating mode selected from remote controller		DHW ON/OFF from remote contact		DHW production operating mode
Force DHW production	→	ON	→	ON
		OFF	→	OFF
Comfort mode	→	ON	→	ON
		OFF	→	OFF
Economy mode	→	ON	→	ON
		OFF	→	OFF
Time bands active (DHW Comfort set point)	→	ON	→	ON
		OFF	→	Comfort setpoint
Time bands active (DHW Economy set point)	→	ON	→	ON
		OFF	→	Economy setpoint
DHW disabled	→	ON	→	ON
		OFF	→	OFF

To enable the domestic hot water function, set parameter 3101=1 or 2 and parameter 5107=1.

The domestic hot water probe (DHW T.probe) is available as an accessory.

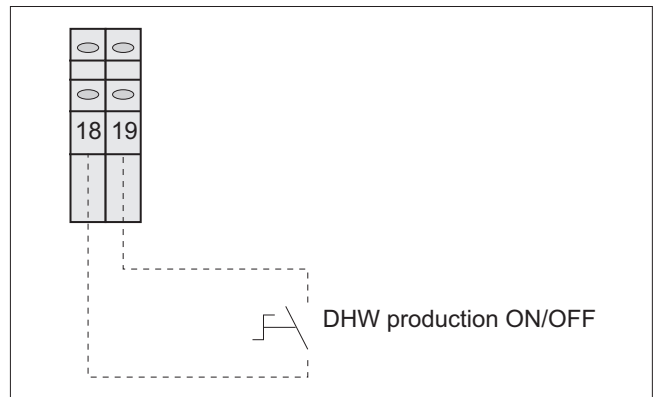

Description	Menu	Parameter no.	Default	Value to be set	UOM
Enable remote contact: 0 = Disabled 1 = Enabled	51	19	0	1	-
Enable DHW function and define operating priority: 0 = DHW function disabled 1 = DHW function enabled and DHW has priority 2 = DHW function enabled and system has priority	31	01	0	-	-
DHW storage tank water temperature probe (DHW T. probe): 0 = Disabled 1 = Enabled	51	07	0	1	-

Contact closed = DHW production enabled
Contact open = DHW production disabled

Remote cooling/heating mode contact (Heating/Cooling mode)

Allows heat pump operation to be switched between cooling and heating via a remote control contact.
If cooling/heating changeover via remote is enabled, mode changeover from keypad will not be possible.

To enable the contact, set the following parameter:

Description	Menu	Parameter no.	Default	Value to be set	UOM
Enable remote cooling/heating contact 0 = Disabled 1 = Enabled: Contact closed =Cooling Contact open = Heating 2 = Enabled: Contact closed =Heating Contact open = Cooling	51	24	0	1 or 2	-

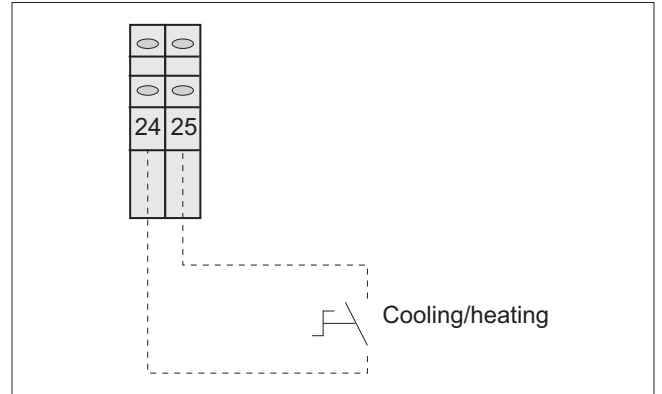

Remote low tariff contact (Low Tariff)

Allows heat pump operation to be activated so as to heat the domestic hot water or cool/heat the storage tank during low tariff times.

Forced loading of the DHW or system storage tank depends on the priority set for parameter 3101.

The DHW storage tank set point is forced to the DHW comfort set point, parameter 3111, when the low tariff contact is closed.

The water temperature set point in heating/cooling with the contact closed is, respectively, increased by the differential set for parameter 2151, and decreased by the differential set for parameter 2152, when the low tariff contact is closed.

To enable the contact, set the following parameters:

Description	Menu	Parameter no.	Default	Value to be set	UOM
Enable remote low tariff contact: 0 = Disabled 1 = Enabled	51	30	0	1	-
Water temperature set point differential (fixed set point or compensation curve) in heating	21	51	5		0,5°C
Water temperature set point differential (fixed set point or compensation curve) in cooling	21	52	5		0,5°C

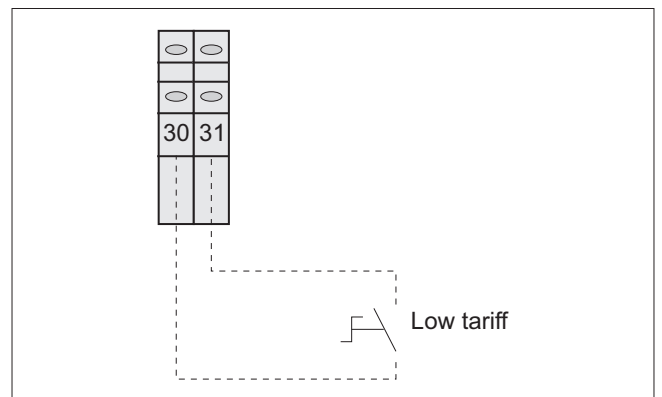

Contact closed = Low tariff function enabled
Contact open = Low tariff function disabled

If the low tariff contact is enabled, parameter 5130=1 night mode contact is also enabled automatically, parameter 5128=1.

Remote night mode contact (Night mode)

Allows compressor frequency to be limited, thus reducing unit noise level and power consumption. Then the contact is closed, the heating or cooling capacity may be insufficient to meet system demand, as compressor frequency is limited by parameter 4111.

To enable the contact, set the following parameters:

Description	Menu	Parameter no.	Default	Value to be set	UOM
Enable remote night mode contact: 0 = Disabled 1 = Enabled	51	28	0	1	-
Maximum frequency value	41	11	80	Min. 50%- Max 100%	5%

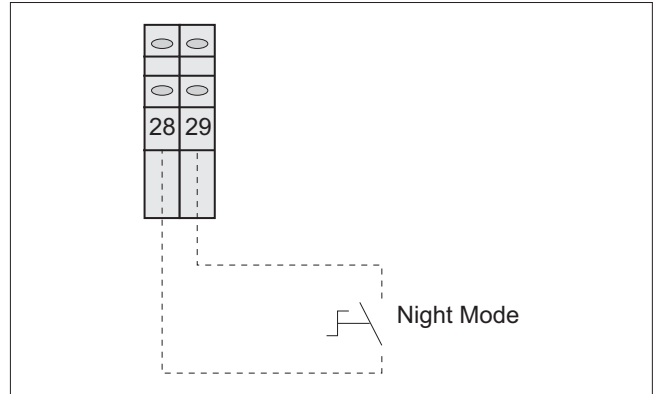

Contact closed = Night mode enabled

Contact open = Night mode disabled

If the night mode contact is enabled, parameter 5128=1, the low tariff contact is also enabled automatically, parameter 5130=1.

Heating/cooling mode output (Heating/Cooling mode output)

Digital output 43-44 is activated based on of heat pump operating mode selected on the remote controller or by the remote cooling/heating contact.

This contact can be used to control system valves or pumps, so as to disable part of the system based on the operating mode. This allows management of mixed systems, for example, radiant panels for heating and fan coils for cooling.

To enable the contact, set the following parameters:

Description	Menu	Parameter no.	Default	Value to be set	UOM
Enable heating/cooling mode output 0 = Disabled 1 = Enabled: Contact closed = Cooling Contact open = Heating 2 = Enabled: Contact closed = Heating Contact open = Cooling	51	43	0	-	-

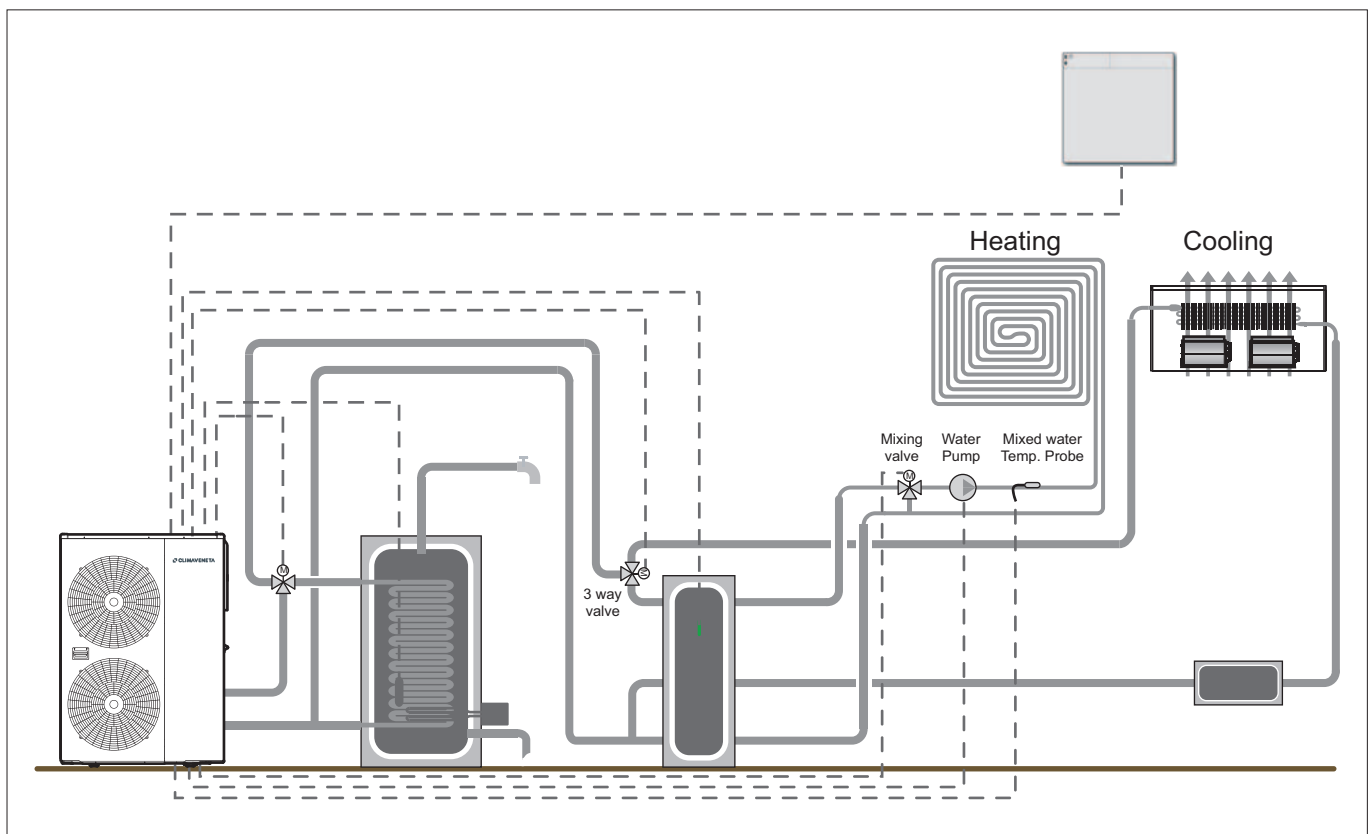

Configurable contact (Alarm/Ambient T. reached)

This contact can be configured to manage the following operating modes:

- Alarm signal contact
- Room set point reached contact

Alarm signal contact

This allows a visual or audible signal device to be activated if the unit stops operating due to a fault.

To enable the contact, set the following parameter:

Description	Menu	Parameter no.	Default	Value to be set	UOM
Enable contact as: 0 = Disabled 1 = alarm signal 2 = room set point reached	51	47	0	1	-

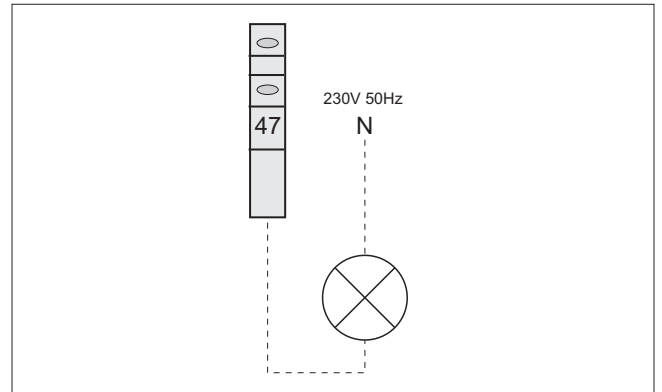

Room set point reached contact

Allows a hydronic terminal (e.g. fan coil) to be activated or deactivated when the room set point is reached, as measured by the probe on the remote controller. The hydronic terminal must in any case be fitted with a dedicated input for selecting the speed and possibly the operating mode.

Suitably set the following parameter:

Description	Menu	Parameter no.	Default	Value to be set	UOM
Enable contact as: 0 = Disabled 1 = alarm signal 2 = room set point reached	51	5147	0	2	-
Reference remote controller to switch off hydronic terminal: 0 = Zone 1 remote controller (MASTER) 1 = Zone 2 remote controller (SLAVE) 2 = MASTER or SLAVE remote controller	04	00	0		-
Room temperature hysteresis for hydronic terminal on/off	04	01	1		0,5°C

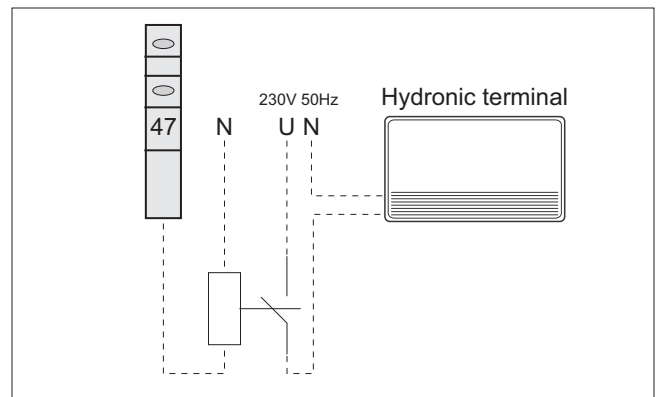

Reference remote controller for room T. measurement	Zone 1 remote controller (MASTER)	Zone 2 remote controller (SLAVE)	Contact no. 47 status	Hydronic terminal operating status
	Room set point	Room set point		
0400 = 0 Zone 1 remote controller (MASTER)	Not reached	/	Closed	ON
	reached	/	Open	OFF
0400 = 1 Zone 2 remote controller (SLAVE)	/	Not reached	Closed	ON
	/	reached	Open	OFF
0400 = 2 MASTER or SLAVE remote controller	Not reached	Not reached	Closed	ON
	reached	Not reached	Closed	ON
	Not reached	reached	Closed	ON
	reached	reached	Open	OFF

**Dual set point contact
(Dual set point)**

Allows a second water temperature set point, either fixed set point or calculated based on the compensation curve, to be activated in order to obtain two temperature levels, for low temperature (zone 1) and high temperature systems (zone 2). The second set point is activated by closing digital input 22-23.

To enable the contact, set the following parameter:

Description	Menu	Parameter no.	Default	Value to be set	UOM
Enable dual set point contact 0 = Disabled 1 = Enabled	51	22	1	-	-

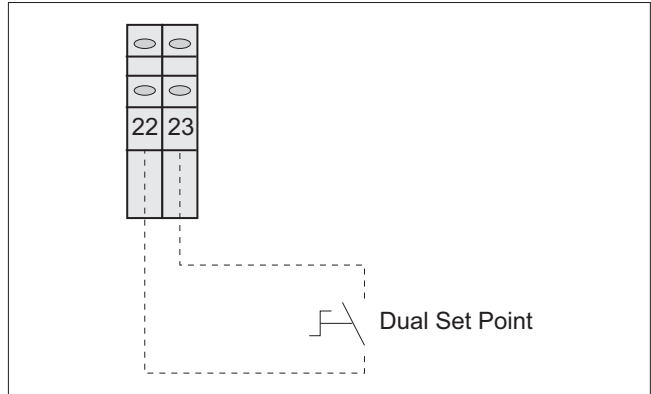

List of parameters for setting second water temperature set point (fixed set point):

Description	Menu	Parameter no.	Default	Value to be set	UOM
Type of zone 2 set point in heating: 0 = fixed set point 1 = compensation curve	21	10	0	0	-
Fixed water outlet temperature set point in heating, zone 2	21	11	45.0	-	0,5°C
Type of zone 2 set point in cooling: 0 = fixed set point 1 = compensation curve	21	30	0	0	-
Fixed water outlet temperature set point in cooling, zone 2	21	31	7.0	-	0,5°C

List of parameters for setting the compensation curve in heating and cooling with second water temperature set point.

The probe on the unit (5109 = 0 default setting) is used to measure the outside air temperature.

In cases where the air temperature probe on the unit cannot provide a correct temperature reading, use the remote outside air temperature probe (5109 = 1), supplied as an accessory.

Description	Menu	Parameter no.	Default	Value to be set	UOM
Type of zone 2 set point in heating: 0 = fixed set point 1 = compensation curve	21	10	0		-
Max. outlet set point in heating (Tm1), zone 2	21	12	45.0		0,5°C
Min. outlet set point in heating (Tm2), zone 2	21	13	30.0		0,5°C
Minimum outside temperature corresponding to max. outlet temperature (Te1), zone 2	21	14	0.0		0,5°C
Maximum outside temperature corresponding to max. outlet temperature (Te2), zone 2	21	15	20.0		0,5°C
Type of zone 2 set point in cooling: 0 = fixed set point 1 = compensation curve	21	30	0		-
Max. outlet set point in cooling (Tm1), zone 2	21	32	20.0		0,5°C
Min. outlet set point in cooling (Tm2), zone 2	21	33	15.0		0,5°C
Minimum outside temperature corresponding to max. outlet temperature (Te1), zone 2	21	34	25.0		0,5°C
Maximum outside temperature corresponding to min. outlet temperature (Te2), zone 2	21	35	35.0		0,5°C

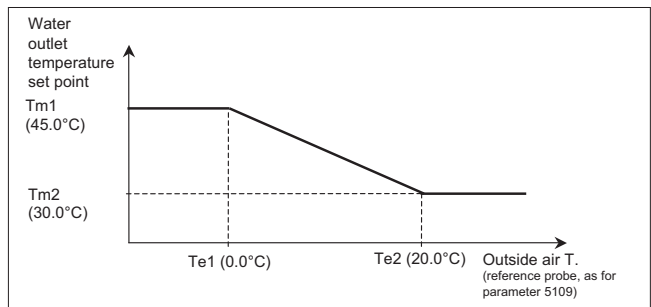

Optional connection

System outlet electric heater (Backup Heater)

Allows an electric heater installed on the outlet to be activated as a supplementary source for the heating system and domestic hot water.

Solution 1

System with heat pump and electric heater with storage tank. Position probe in the storage tank

Solution 2

System with heat pump and outlet electric heater WITHOUT storage tank. Position probe on the system outlet pipe.

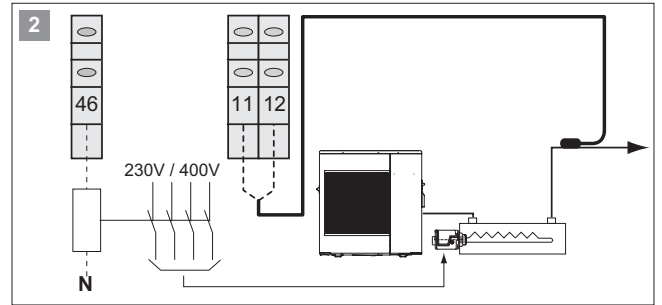
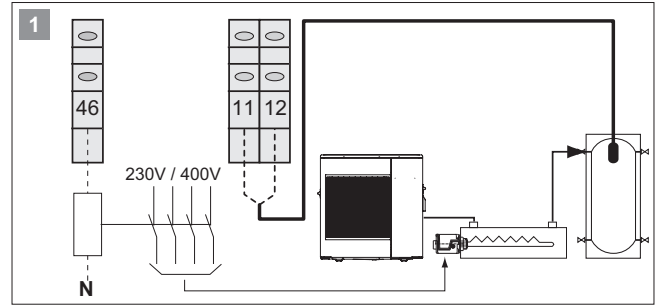

Outlet electric heater control

A) REPLACEMENT: The electric heater is enabled when the outside temperature is less than the value of parameter 4611 and the compressor is off, figure 3.

To enable heater activation in REPLACEMENT mode set parameter 4600=1 and 4610=1.

The electric heater works so as to reach the water temperature set point, either calculated based on the compensation curve or fixed, for the heating system and, if enabled for domestic hot water production (3102=0), works so as to reach the DHW Comfort or Economy set point.

DHW overboost set point not available.

If the heat pump shuts down due to an alarm, the electric heater is activated automatically regardless of the outside air temperature.

In REPLACEMENT mode the electric heater activation delay time is ignored, and the device is activated immediately if necessary.

B) SUPPLEMENTARY: the electric heater operates in supplementary heating mode, together with the compressor, to satisfy the heating load.

Supplementary heating for low outside air temperature

The electric heater as a supplementary heat source is only enabled when the outside temperature is less than the value of 4611.

An outside air temperature can also be set (4611), below which the compressor is off and only the electric heater remains active, see Figure 4. In this case, the heater works as described in paragraph "A) Replacement".

To activate the heater as a SUPPLEMENTARY heat source, set parameter 4600=3 and 4610=1.

Electric heater operation reflects the trend in water outlet temperature, as shown on the graph in figure 5.

It works so as to reach the water temperature set point, either calculated based on the compensation curve or fixed, for the heating system and, if also enabled for domestic hot water production (3102=0), works so as to reach the DHW Comfort or Economy set point.

DHW overboost set point not available.

Outlet electric heater operating parameters in REPLACEMENT mode

Description	Menu	Parameter no.	Default	Value to be set	UOM
Enable contact 46 0 = DHW electric heater 1 = Backup electric heater	51	46	0	1	-
Backup heater: 0 = disabled 1 = replacement 2 = emergency 3 = supplementary	46	00	0	1	-
Enable for low outside air temperature 0 = Disabled 1 = Enabled	46	10	1	-	-
Outside air temperature to enable backup electric heater	46	11	-5	-	0,5°C

Outlet electric heater operating parameters in SUPPLEMENTARY mode for OUTSIDE AIR TEMP.

Description	Menu	Parameter no.	Default	Value to be set	UOM
Enable contact 46 0 = DHW electric heater 1 = Backup electric heater	51	46	0	1	-
Backup heater: 0 = disabled 1 = replacement 2 = emergency 3 = supplementary	46	00	0	3	-
Electric heater activation delay time (allows the heat pump to reach steady operation and thus avoid activating the heater when not needed)	46	04	5	-	1min
Integral time to activate outlet electric heaters	46	05	600	-	°C* sec
Enable for low outside air temperature 0 = Disabled 1 = Enabled	46	10	1	-	-
Outside air temperature to enable backup electric heater as a replacement heat source(heater only)	46	11	-5	-	0,5°C
Outside air temperature to enable backup electric heater as a supplementary heat source (backup heater + compressor)	46	13	5	-	0,5°C

Supplementary heating always enabled

Supplementary heating with the electric heater is enabled for all outside air temperatures.

To enable heating at all times set parameter 4600=3 and 4610=0.

Electric heater operation reflects the trend in water outlet temperature, as shown on the graph in figure 5.

It works so as to reach the water temperature set point, either calculated based on the compensation curve or fixed, for the heating system and, if also enabled for domestic hot water production (3102=0), works so as to reach the DHW Comfort or Economy set point.

DHW overboost set point not available.

Outlet electric heater operating parameters in SUPPLEMENTARY mode when always ENABLED

Description	Menu	Parameter no.	Default	Value to be set	UOM
Enable contact 46 0 = DHW electric heater 1 = Backup electric heater	51	46	0	1	-
Backup heater: 0 = disabled 1 = replacement 2 = emergency 3 = supplementary	46	00	0	3	-
Electric heater activation delay time (allows the heat pump to reach steady operation and thus avoid activating the heater when not needed)	46	04	5	-	1min
Integral time to activate outlet electric heaters	46	05	600	-	°C*sec
Enable for low outside air temperature 0 = Disabled 1 = Enabled	46	10	0	-	-

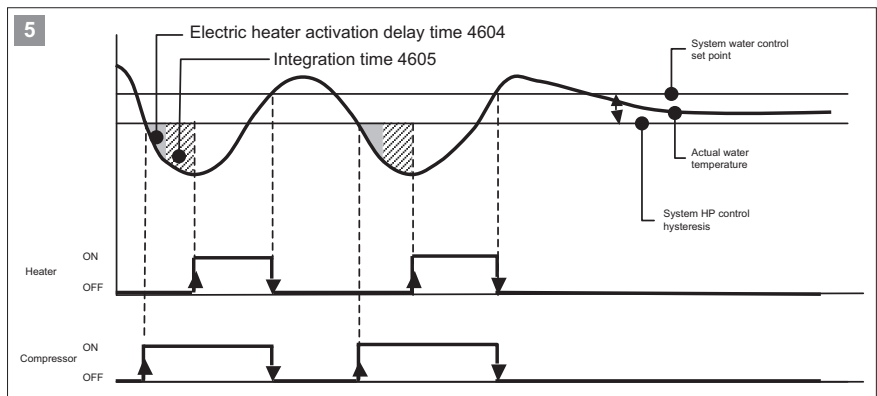
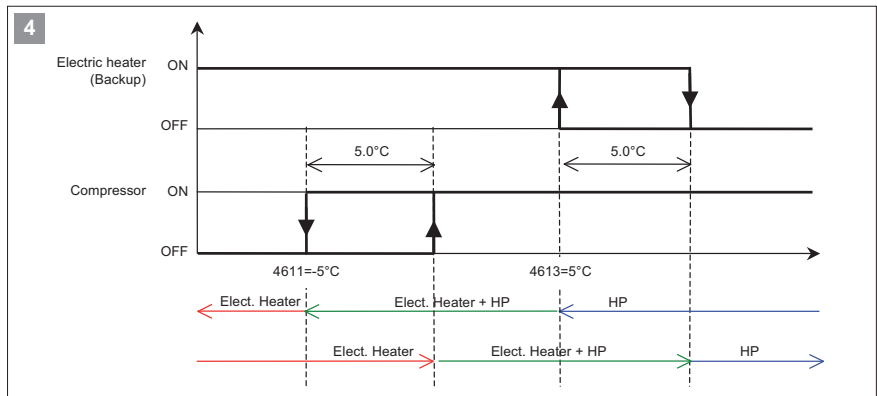
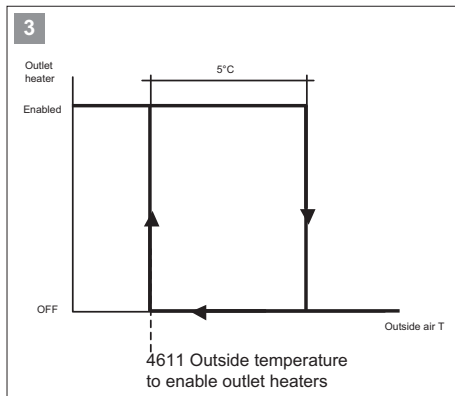

Once the heater is enabled, supplementary heating is activated when the integration time set for parameter 4605 is reached and the delay time 4604 has elapsed. The delay time is ignored when the unit is first started.

Example:

Value 4605 = 600°C*sec

Outlet temperature set point= 50°C

Actual temperature = 40°C

$(50 - 40) \times 60 \text{ sec} = 600^\circ\text{Csec}$. ----> Electric heater ON

Low values of 4605 mean frequent activation of the heater.

Too high values of 4605 mean long delays in activating the heater

Auxiliary heat source (EHS)

A boiler can be used as a supplementary or replacement heat source for the system.

Solution 1

System with heat pump and boiler with storage tank.

Solution 2

System with heat pump and boiler without storage tank.

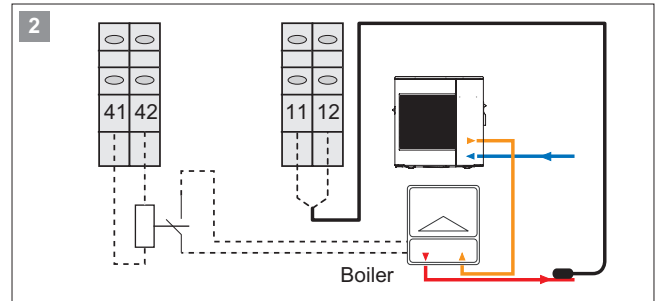
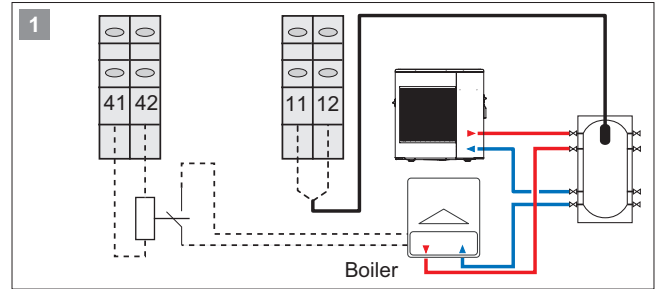

Boiler control

A) REPLACEMENT: the boiler is only enabled if the outside air temperature is less than the value of parameter 4702 and the compressor is off, figure 3.

To enable boiler activation in REPLACEMENT mode set parameter 4700=1 and 4701 = 1

The boiler works so as to reach the heating system water temperature set point, either calculated by the compensation curve or fixed.

If the heat pump shuts down due to an alarm the boiler is activated automatically regardless of the outside air temperature.

In REPLACEMENT mode the activation delay time is ignored, and the boiler is activated immediately if necessary.

B) SUPPLEMENTARY: the boiler operates in supplementary heating mode, together with the compressor, to satisfy the heating load.

Supplementary heating for low outside air temperature

The boiler as a supplementary heat source is only enabled when the outside air temperature is less than the value of 4704.

An outside air temperature can also be set (4702), below which the compressor is off and only the boiler remains active, see Figure 4.

In this case, the boiler works as described in paragraph "A) Replacement".

To enable the supplementary heating for outside air temperature set parameter 4700 = 1 and 4701 = 0

Boiler operation reflects the trend in water temperature, as shown on the graph in figure 5.

It works so as to reach the water temperature set point, either calculated based on the compensation curve or fixed, for the heating system and.

Boiler operating parameters in REPLACEMENT mode

Description	Menu	Parameter no.	Default	Value to be set	UOM
Enable contact 41-42 0 = disabled 1 = enabled	51	41	0	1	-
Auxiliary heat source (EHS): 0 = disabled 1 = replacement 2 = supplementary	47	00	0	1	-
Enable for low outside air temperature 0 = Disabled 1 = Enabled	47	01	1	-	-
Outside air temperature to enable EHS	47	02	-5	-	0,5°C

Boiler operating parameters in SUPPLEMENTARY mode for outside temperature

Description	Menu	Parameter no.	Default	Value to be set	UOM
Enable contact 41-42 0 = disabled 1 = enabled	51	41	0	1	-
Auxiliary heat source (EHS): 0 = disabled 1 = replacement 2 = supplementary	47	00	0	2	-
EHS activation delay time (allows the heat pump to reach steady operation and thus avoid activating the auxiliary heat source heater when not needed)	47	06	5	-	1 min
Integral time to activate outlet electric heaters	47	07	600	-	°C* sec
Enable for low outside air temperature 0 = Disabled 1 = Enabled	47	01	1	1	-
Outside air temperature to enable EHS as a replacement heat source (EHS only)	47	04	5	-	0,5°C
Outside air temperature to enable EHS as a supplementary heat source (EHS + compressor)	47	02	-5	-	0,5°C

Supplementary heating always enabled

Supplementary heating by boiler is enabled for all outside air temperatures.

To enable heating at all times set parameter 4700 = 0 and 4701 = 0

Boiler operation reflects the trend in water temperature, as shown on the graph in figure 5.

It works so as to reach the water temperature set point, either calculated based on the compensation curve or fixed, for the heating system and.

Boiler operating parameters in SUPPLEMENTARY mode when always ENABLED

Description	Menu	Parameter no.	Default	Value to be set	UOM
Enable contact 41-42 0 = disabled 1 = enabled	51	41	0	1	-
Auxiliary heat source (EHS): 0 = disabled 1 = replacement 2 = supplementary	47	00	0	2	-
EHS activation delay time (allows the heat pump to reach steady operation and thus avoid activating the auxiliary heat source when not needed)	47	06	5	-	1min
Integral time to activate outlet electric heaters	47	07	600	-	°C* sec
Enable for low outside air temperature	47	01	1	1	-

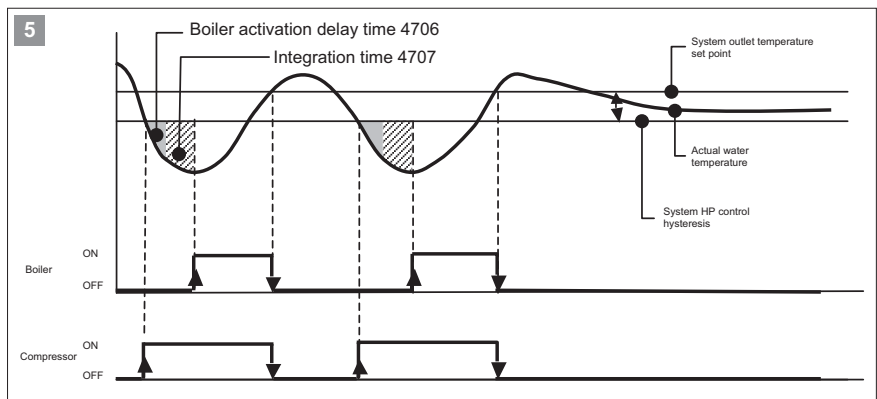
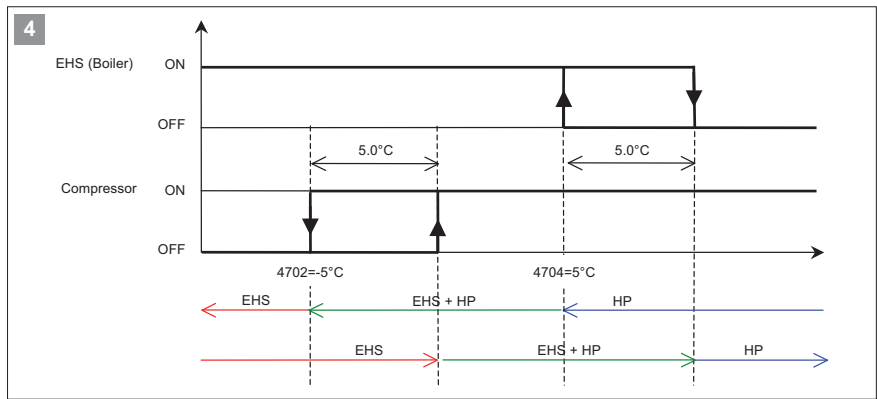
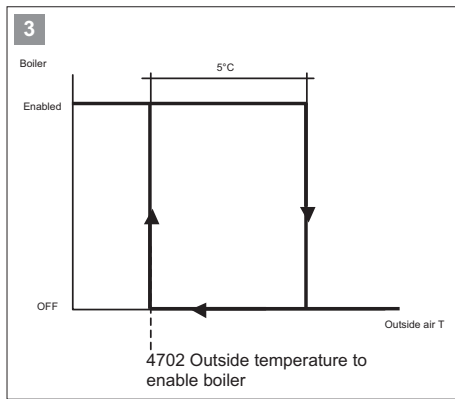

Once the boiler has been enabled, supplementary heating is activated when the integration time set for parameter 4707 is reached and the delay time 4706 has elapsed. The delay time is ignored when the unit is first started.

Example:

Value 4707 = 600°C*sec

Outlet temperature set point= 50°C

Actual temperature = 40°C

$(50 - 40) \times 60 \text{ sec} = 600^\circ\text{Csec}$. ----> Boiler ON

Low values of 4707 mean frequent activation of the boiler.

Too high values of 4707 mean long delays in activating the boiler

DHW storage electric heater contact

An electric heater can be managed for heating the DHW storage.

DHW storage electric heater control

The electric heater is activated to reach a temperature value that the heat pump on its own is not able to reach.

Example:

Domestic hot water temperature produced using heat pump 3111=55°C DHW Comfort set point or 3112=40°C Economy set point.

Domestic hot water temperature produced using electric heater 3114=65°C overboost set point. The electric heater works so as to increase the DHW storage temperature from 55°C or 40°C to the overboost set point, Figure 1.

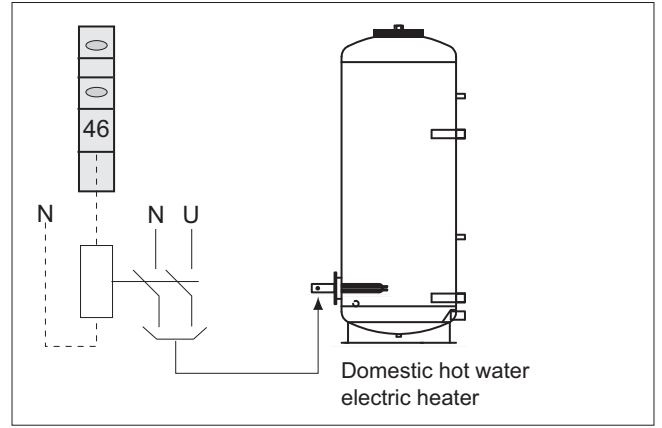

Description	Menu	Parameter no.	Default	Value to be set	UOM
Enable contact 46 0 = DHW electric heater 1 = Backup electric heater	51	46	0	0	-
DHW electric heater operating mode 0 = Heat pump + DHW electric heater 1 = Heat pump only 2 = DHW electric heater only	31	02	1	0	-
DHW overboost set point	31	14	60	-	0,5°C

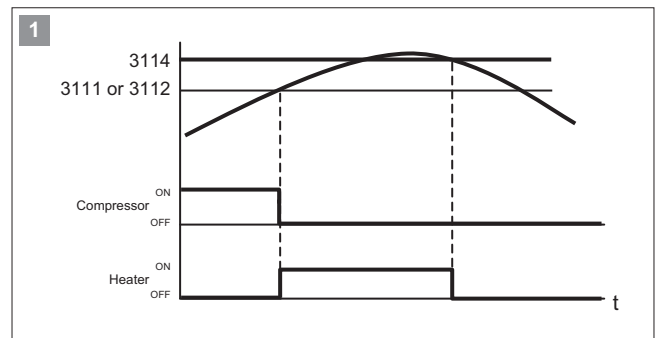

The DHW electric heater can be activated at any outside air temperature when parameter 3132=0, or only when the outside air temperature is less than the value set for parameter 3133 and when parameter 3132=1.

Description	Menu	Parameter no.	Default	Value to be set	UOM
Enable DHW electric heater for outside air temperature 0 = always enabled 1 = enabled based on outside air T.	31	32	1	1	-
Outside air temperature to enable DHW electric heater	31	33	-5	-	0,5°C

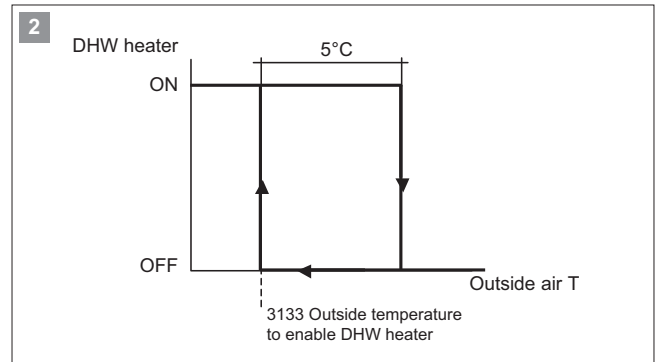

The DHW electric heater is activated when the unit works outside of the operating limits. The compressor stops and the heater is activated, so as to heat the domestic hot water until reaching the DHW overboost set point, parameter 3114.

Legionella prevention function with electric heater

The Legionella prevention function ensures the elimination of the Legionella bacteria that reside in domestic water storage tanks. The temperature and duration of the Legionella prevention cycles are typically:

- 2 minutes > 70°C
- 4 minutes > 65°C
- 60 minutes > 60°C

To enable the Legionella prevention function, set 3140=1.

The Legionella prevention function is only available if the DHW electric heater is installed and if parameter 5146=0

Description	Menu	Parameter no.	Default	Value to be set	UOM
Enable contact 46 0 = DHW electric heater 1 = Backup electric heater	51	46	0	0	-
DHW electric heater operating mode 0 = Heat pump + DHW electric heater 1 = Heat pump only 2 = DHW electric heater only	31	02	1	0	-
Enable Legionella prevention function: 0 = Disabled 1 = Enabled	31	40	0	1	-
Legionella prevention cycle day 0 = Mon 1 = Tue 2 = Wed 3 = Thu 4 = Fri 5 = Sat 6 = Sun	31	41	0	-	-
Legionella prevention cycle time	31	42	1:00	-	1:00
Legionella prevention cycle duration	31	43	10	-	1min
Legionella prevention set point	31	44	65	-	0,5°C

System flow switch (Flow switch)

System flow switch connection, compulsory component.

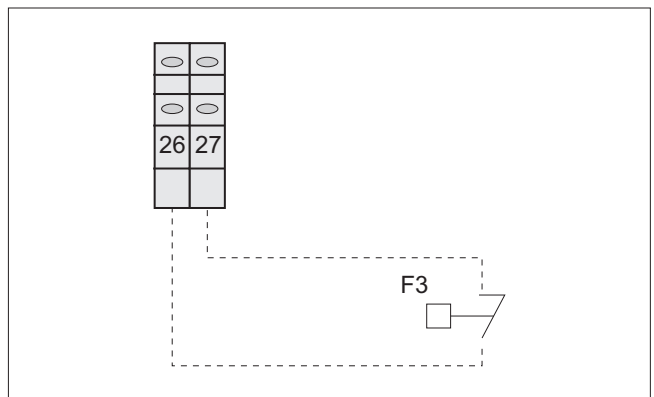

			i-KIR2 MTD		
			0011m	0031m	0061m
Rated heating capacity	1	kW	5,85	9,23	15,70
Total power consumption	1	kW	1,46	2,19	3,84
COP EN14511	1		4,01	4,22	4,10
Cooling capacity	2	kW	4,40	8,00	16,20
Total power consumption	2	kW	1,06	2,30	4,19
EER EN14511	2		4,15	3,48	3,87
Heating capacity	3	kW	5,30	9,37	14,70
Total power consumption	3	kW	1,74	2,90	4,55
COP EN14511	3		3,05	3,23	3,23
Cooling capacity	4	kW	3,70	5,20	12,30
Total power consumption	4	kW	1,28	1,90	3,77
EER EN14511	4		2,89	2,74	3,26
ESEER	4		4,00	4,17	3,90
Type of compressor			Rotary DC Inverter	Scroll DC Inverter	Twin Rotary DC Inverter
No. of compressors			1	1	1
Refrigerant			R410A	R410A	R410A
No. of fans			1	1	2
Type of system pump	5		Ci	Ci	Ci
Power supply		V-ph-Hz	230-1-50	230-1-50	230-1-50
Sound power	6	dB(A)	60	64	65
Sound pressure	7	dB(A)	46	50	51
OUTDOOR UNIT DIMENSIONS					
L		mm	825	850	1000
P		mm	300	330	330
H		mm	675	882	1418
Operating weight		kg	59	77	119

Notes

- 1 System water temperature 30/35°C, outside air temperature 7°C DB/ 6°C WB
- 2 System water temperature 23/18°C, outside air temperature 35°C DB
- 3 System water temperature 40/45°C, outside air temperature 7°C DB/ 6°C WB
- 4 System water temperature 12/7°C, outside air temperature 35°C DB
Total power consumption calculated by adding compressor and fan power consumption.
- 5 Ci=Circulating pump
- 6 Sound power in accordance with ISO 9614 and Eurovent 8/1
- 7 Average sound pressure on reflecting surface (Q=2) at a distance of 1 metre from the outside of the unit.

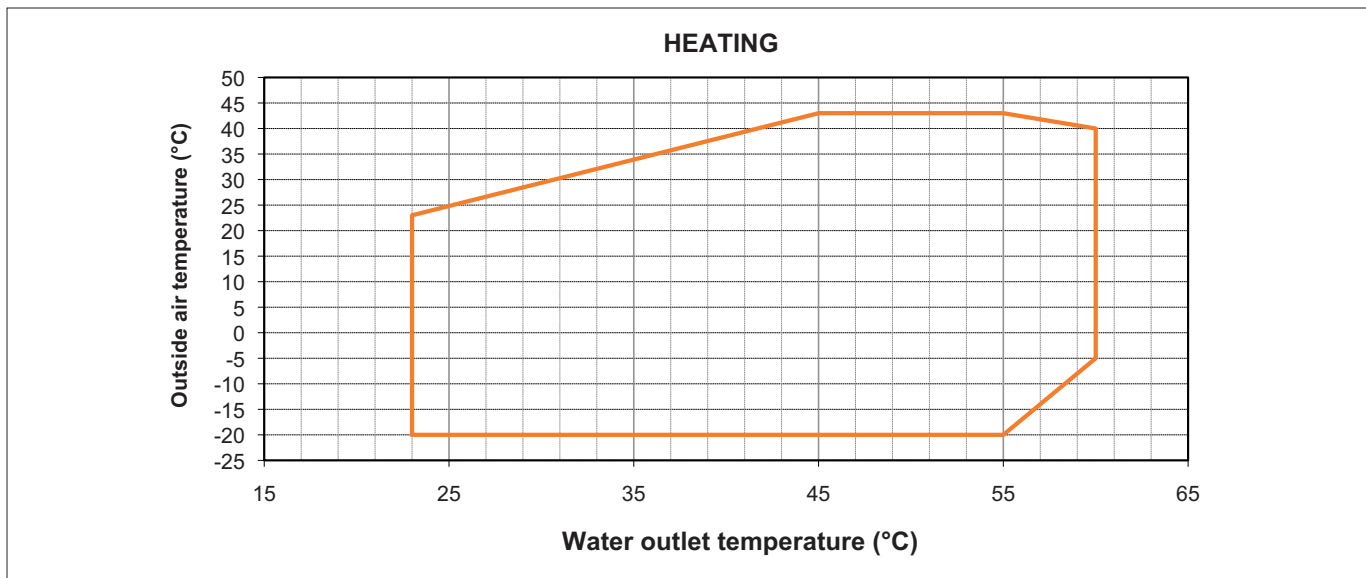
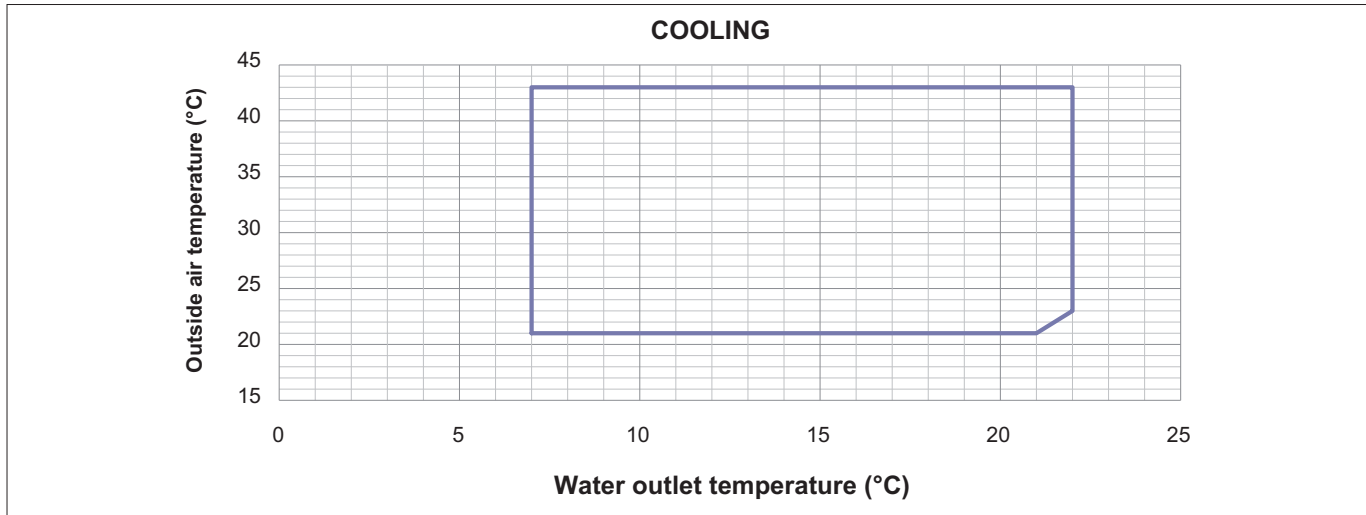

Min/max water temperature difference = 5/10 °C (in minimum flow conditions, 7 l/min)

MAX return temperature to heat pump = 55°C

MAX outlet temperature to heat pump for DHW production = 58°C

Water circuit pressure min/max = 1/3 bar

Maximum glycol percentage = 40%

The temperature of the fluid leaving the unit must always be within the manufacturer's specified operating range, even during start-up and when first putting into heating mode. To ensure this, the water circuit can be fitted with a bypass valve and/or other solutions, such as electric heaters with temperature control inside the storage tank.

PUMP CHARACTERISTICS

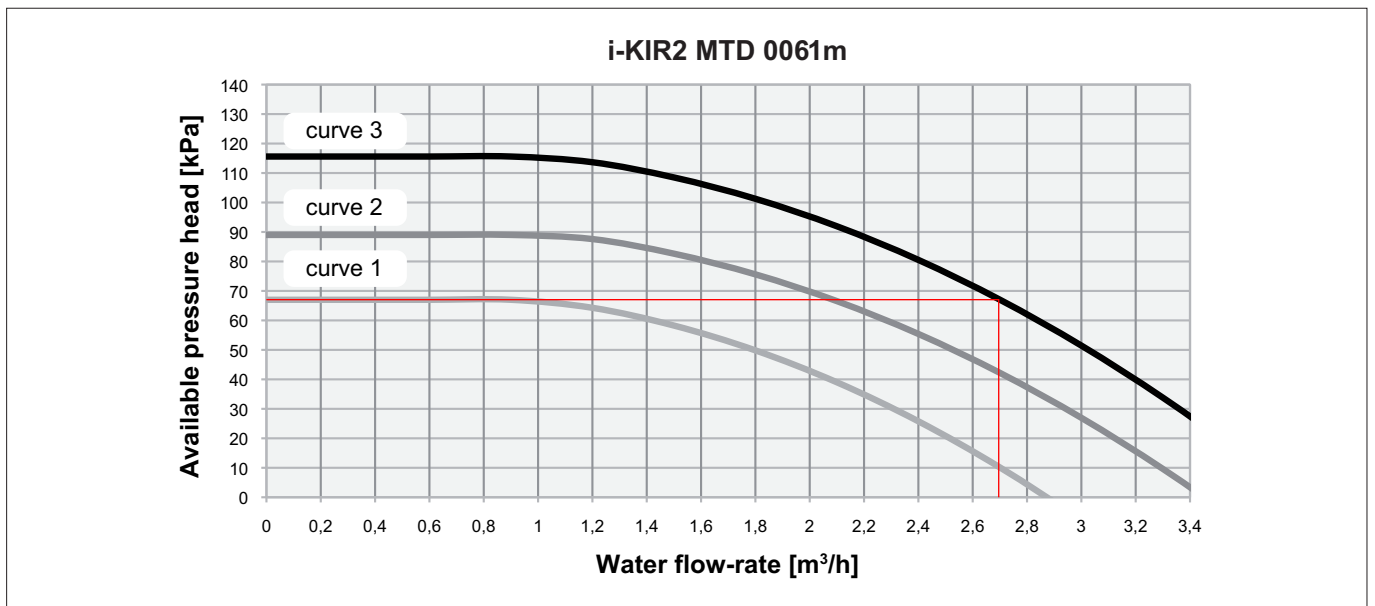
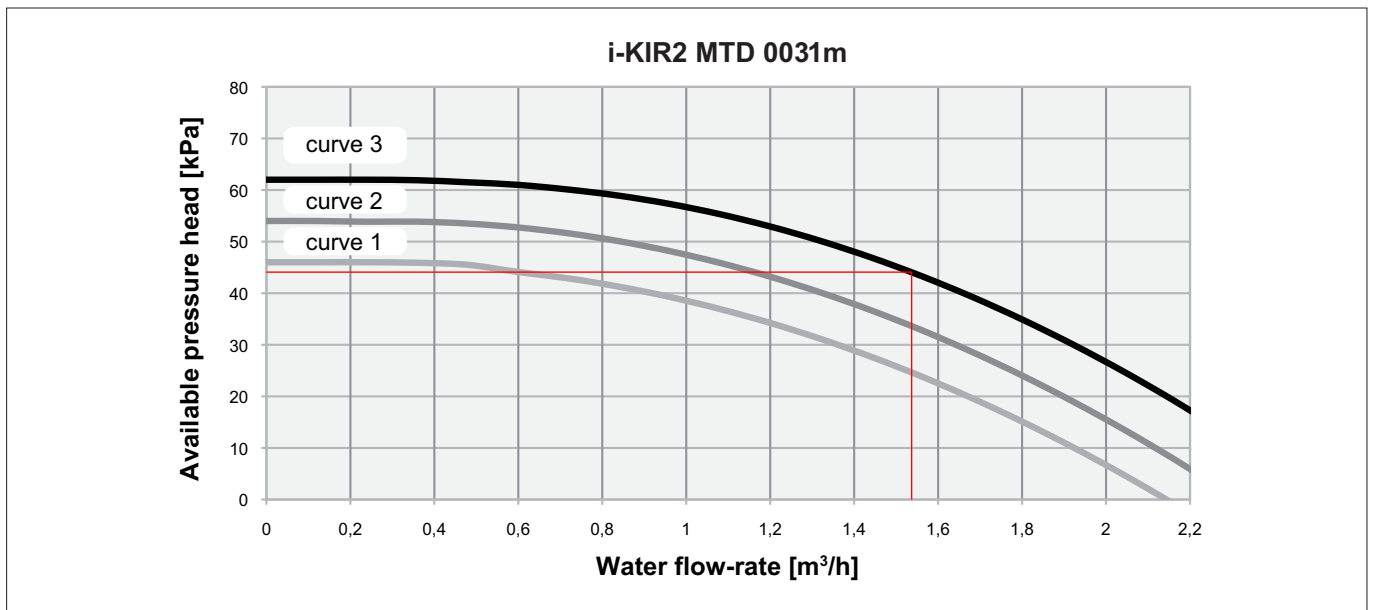
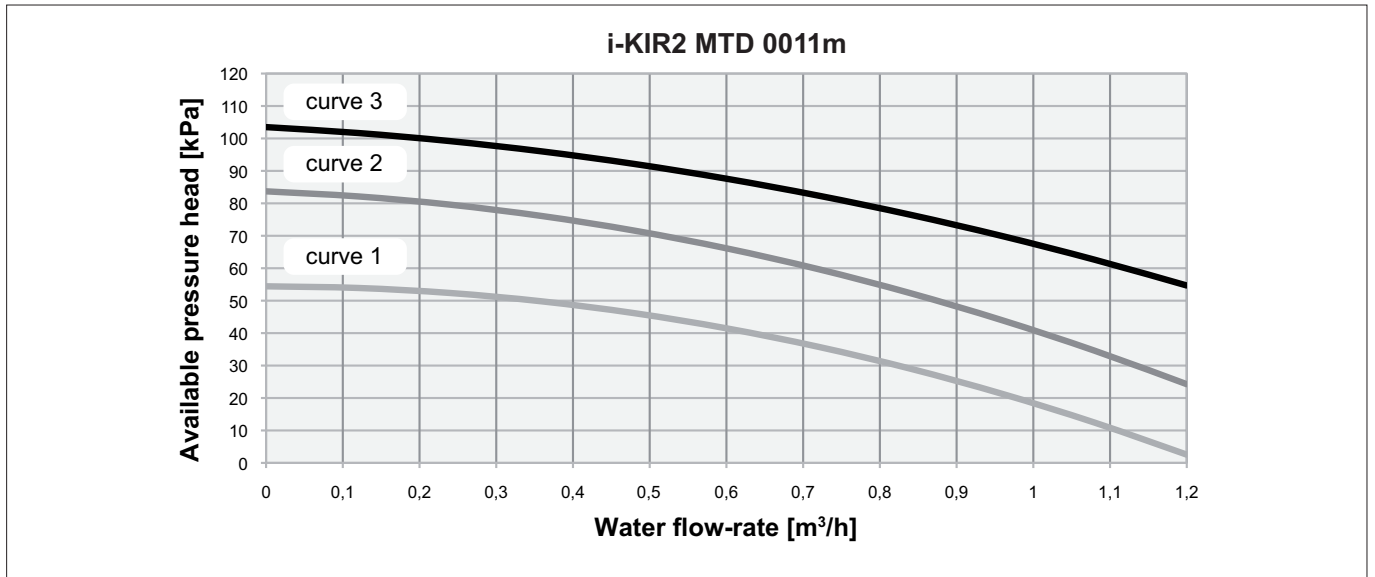

The pressure head values refer to the values available at the water connections.

CHECKS BEFORE STARTING THE UNIT

- the vibration damping feet are fitted
- inlet filters are fitted on the system
- suitably-sized expansion vessel and safety valve installed on the DHW circuit
- an expansion vessel is installed
- make sure vibration damper joints are installed on water connections
- a low-loss header is installed if the water content is insufficient

- make sure the position of the outside air probe corresponds to the instructions shown in the manual
- make sure the position of the room control unit corresponds to the instructions shown in the manual
- make sure that the electrical power available is adequate for the unit installed
- make sure the non-return valve is installed on the DHW circuit

PREPARING FOR FIRST START UP

The unit must be started up for the first time by the **Technical Service**. Before starting up the unit, make sure that:

- the unit has been properly installed as described in this manual
- All safety conditions have been respected;;
- The unit is adequately fixed to the surface it rests on;
- Clearances have been respected;
- Water connections have been carried out as indicated in the instruction manual;
- All water connections are tight.
- Make sure the water circuit has been washed and drained.
- The water circuit is filled and vented.
- Make sure there is no air in the system. If necessary vent the system using the vent valve.

If venting after operation in heat pump mode, be careful as the water may be hot;

To assist venting of the air, the unit's pump can be started, by pressing the PUMP SW button.

The pump will stop automatically after 10 minutes.

- The water valves are open;
- Electrical connections have been carried out correctly;

- Voltage is within a tolerance of 10% of the rated voltage for the unit;
- Make sure that unbalance between phases is less than 2%, for three-phase units.
- The unit is correctly earthed;
- All electrical connections are tight.
- make sure that the outside air and water temperature are within the unit operating limits shown in this manual.

STARTING UP FOR THE FIRST TIME

Before starting the unit:

- Make sure the switch QF1 is in the OFF position, Fig. 1.
- Make sure the contact of the on/off device SA1 (see the wiring diagram) is open (if featured).
- Make sure the remote controller is off.

- Position the main unit switch QS1 in the ON position, Fig. 2.

- Move switch QF1 (outside the unit) to "ON", Fig. 3.

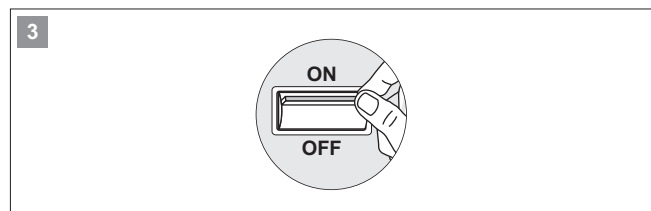
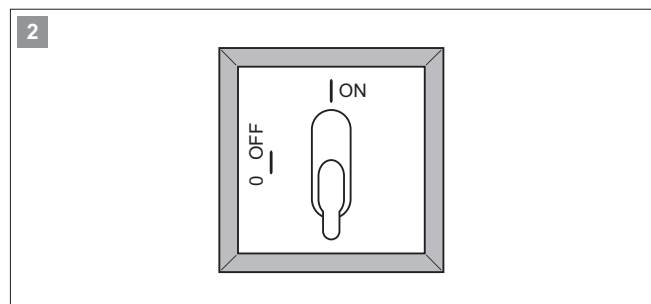
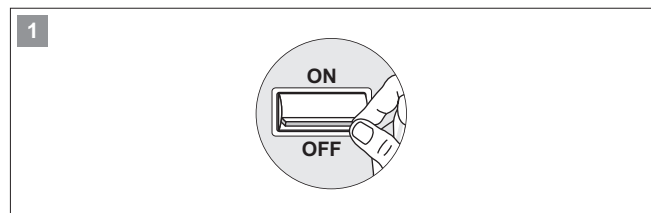

- Once having powered up the heat pump, the display on the room control unit shows this message:

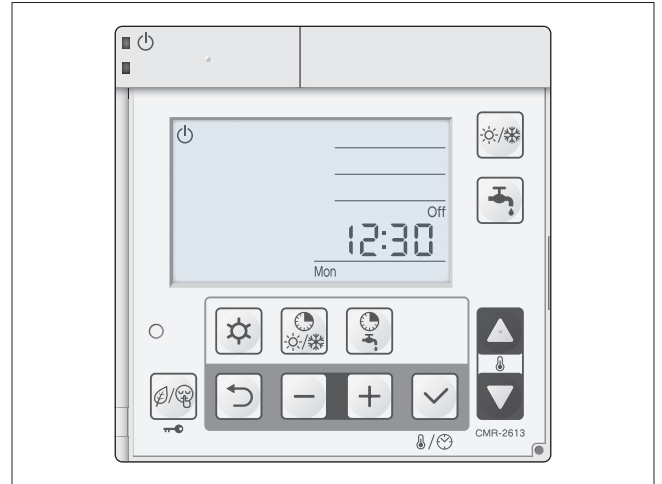

When commissioning the heat pump, the following steps are required:

- Set the current date and time
- Configure the type of system and the number of room controllers
- Switch on the unit by pressing button 1
- Select the required operating mode by pressing button 2
- Select the desired room temperature, pressing the arrow buttons - 3
- Enable DHW production, if featured, by pressing button 4

For further information on the operation and functions of the room controller, see "Operation and functions of the room controller".

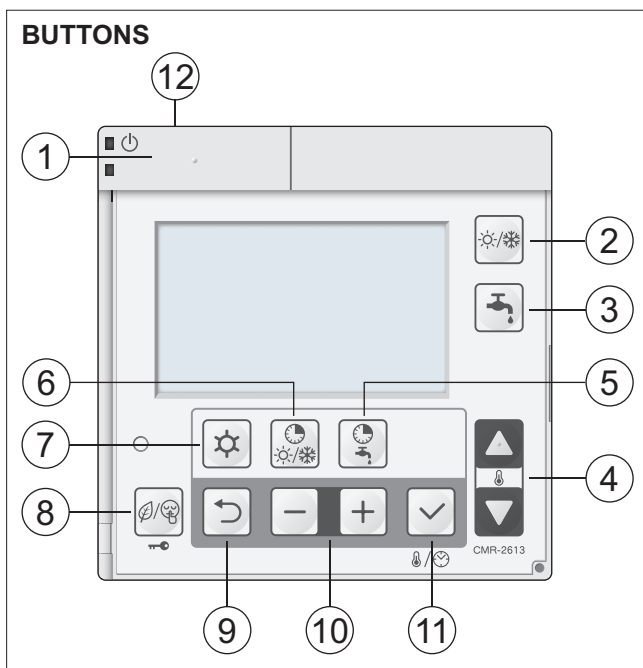
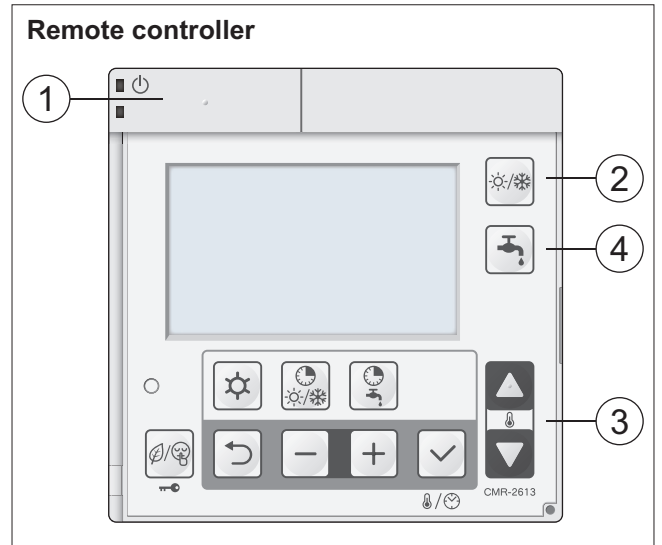

N°	Description
1	ON/OFF button
2	Operating mode button
3	Domestic hot water production (DHW) button
4	Buttons for setting room temperature and parameters
5	Enable DHW time bands button
6	Enable Heating / Cooling time bands button
7	Programming button
8	Enable Low Tariff function, Night Mode and Lock keypad button
9	Exit button when programming parameters
10	Buttons for setting the parameter values
11	Button for confirming the value in programming mode, and pressed repeatedly to display, in sequence, clock, room humidity, room T. set point
12	Room temperature probe

DISPLAY

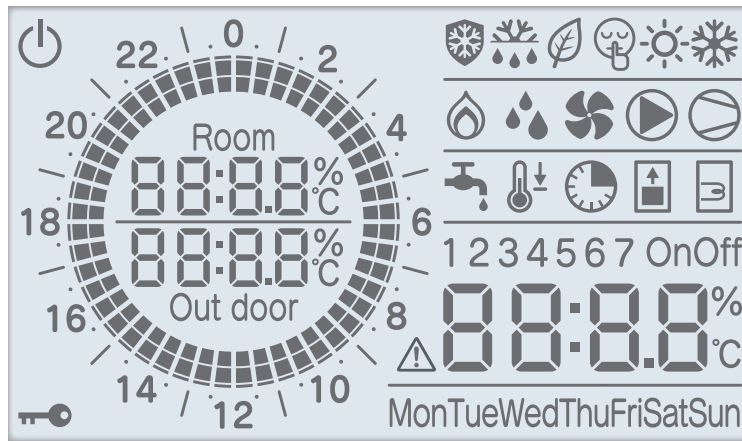

Symbol	Description
	Unit powered but in standby
	Lock keypad active
	Frost protection active
	Defrost cycle active
	Low tariff mode active
	Night mode active
	Heating mode
	Cooling mode
	Supplementary sources active
	Dehumidifier active
	Fan active
	Circulator pump active
	- Flashing: compressor timer, waiting - On steady: compressor active*
	- On steady DHW production active, COMFORT set point - Flashing if unit operating for the heating system
	DHW production active, ECONOMY set point

Symbol	Description
	DHW time bands active
	Forced domestic hot water production
	DHW electric heater active
OnOff	Time bands active: - Heat pump time band ON - Heat pump time band OFF
	Alarm signal and error code
	Displays the time, room temperature set point, humidity and parameter number
MonTueWedThuFriSatSun	Day of the week
	Displays room temperature and outside air temperature
	Displays system time bands. 15min. 15min. Each segment corresponds to 15 minutes

* Any delays in the "compressor" symbol switching off are due to the PI calculation of the compensation curve.

Meaning of the symbols

Symbol	Meaning
	Press and release
	Hold for 3 seconds

Setting the time and date

- 1 Press for 3 seconds, the day flashes - "Mon"
- 2 Select the day by pressing
- 3 Confirm the day by pressing

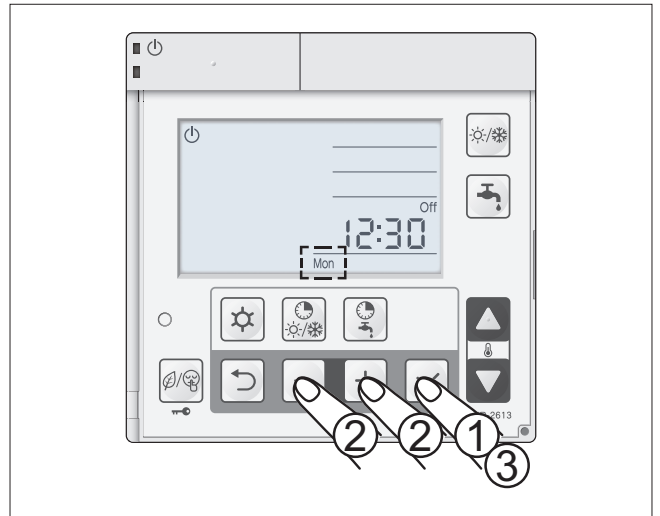

Once having confirmed the day, the hour and minutes flash.

- 4 Set the hour and minutes by pressing
- 5 Confirm the time by pressing

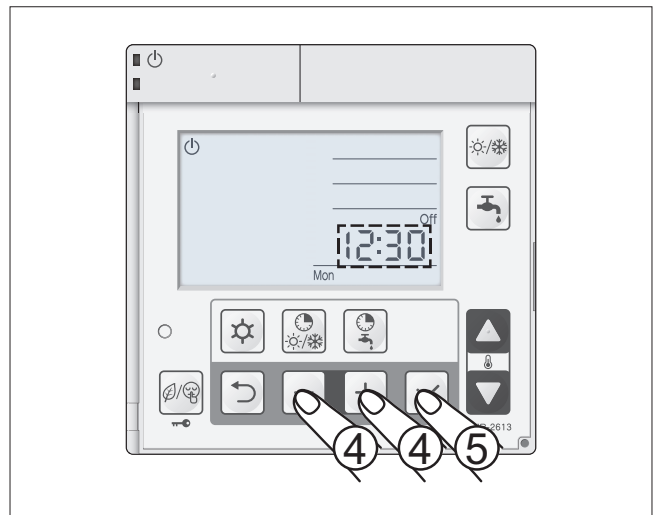

- Mon** = Monday,
- Tue** = Tuesday,
- Wed** = Wednesday,
- Thu** = Thursday,
- Fri** = Friday,
- Sat** = Saturday,
- Sun** = Sunday

Switching ON

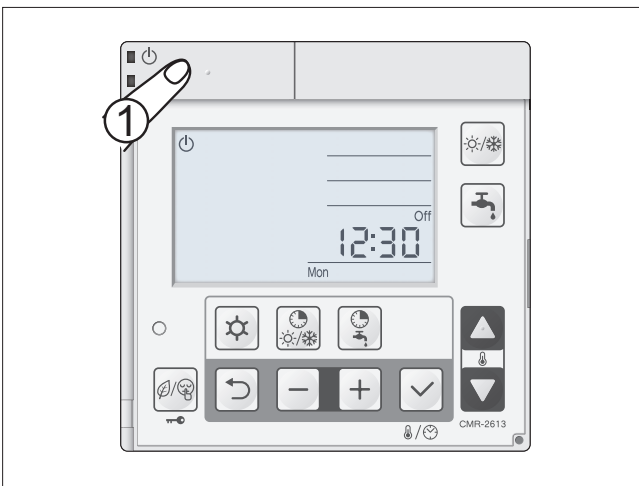

- 1 Press and hold ON/OFF for 3 seconds

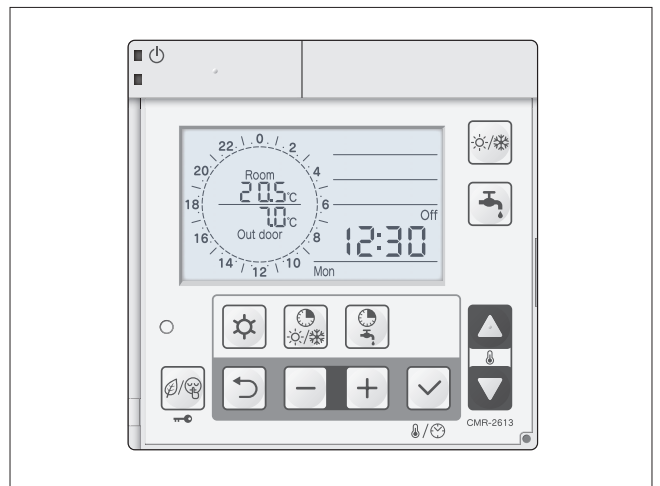

The display switches on, and the zone controlled by the reference controller will be active. The heat pump will only start after having selected the operating mode: heating, cooling, DHW.

Selecting the operating mode

1 No operating mode selected.
Heat pump OFF.

2 Select the operating mode by pressing
HEATING mode 

2 Select the operating mode by pressing
COOLING mode 

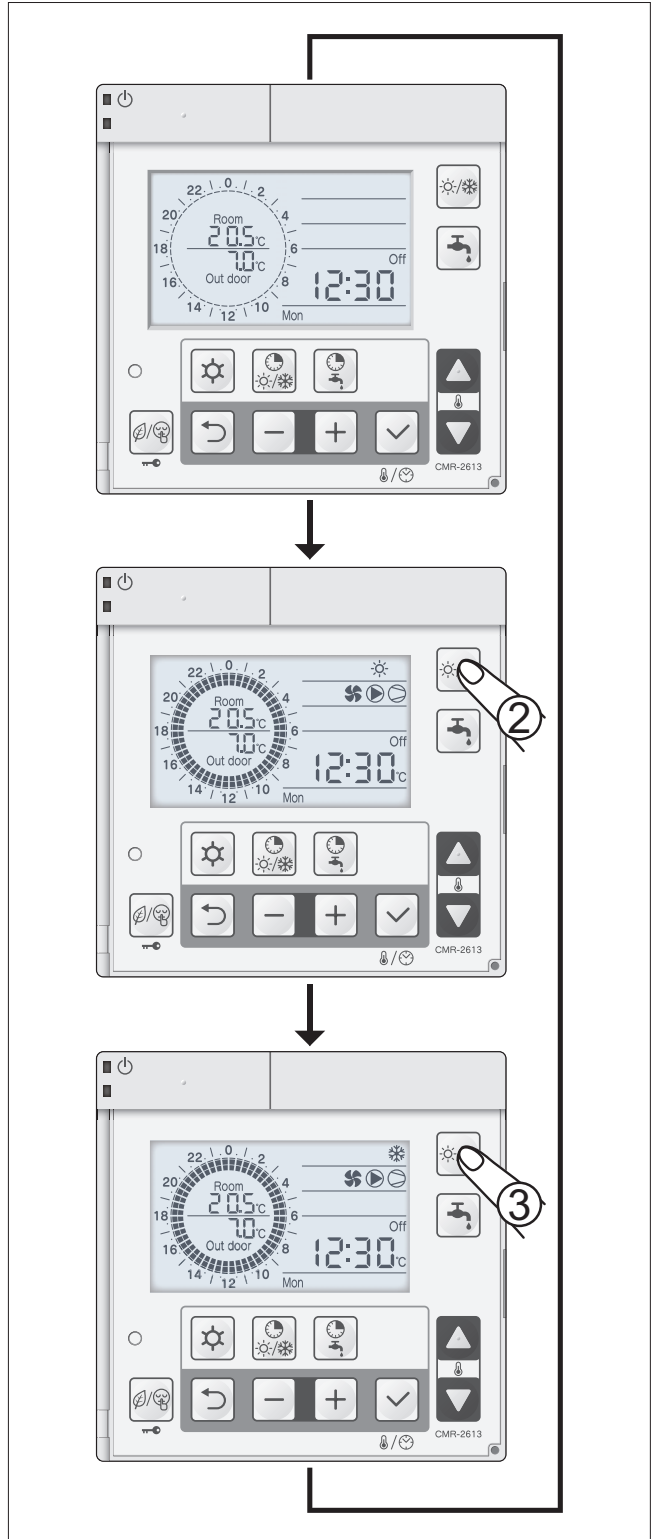

Selecting the room set point

- 1 Press .

The display shows the room set point instead of the clock.

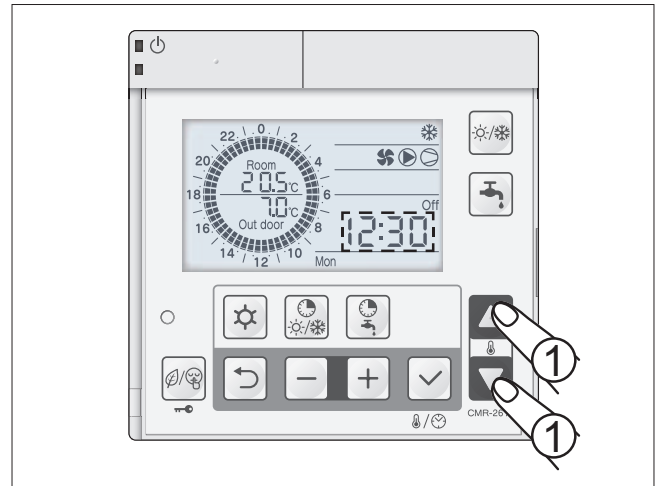

- 1 Select the desired room set point by pressing .

After a few seconds, the clock will be displayed again.

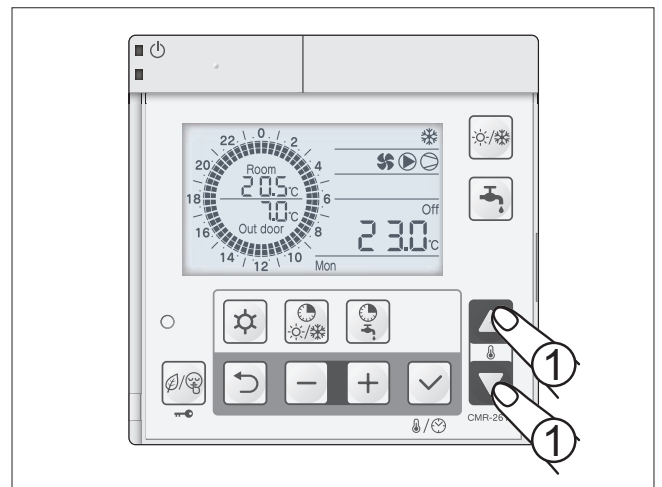

Domestic hot water production

1 No DHW operating mode selected.

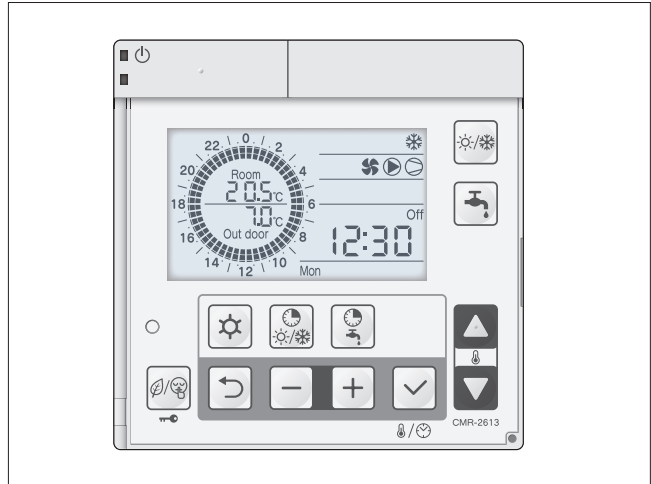

2 Press .

The display shows the  icon.
DHW production Comfort set point (par 3111).

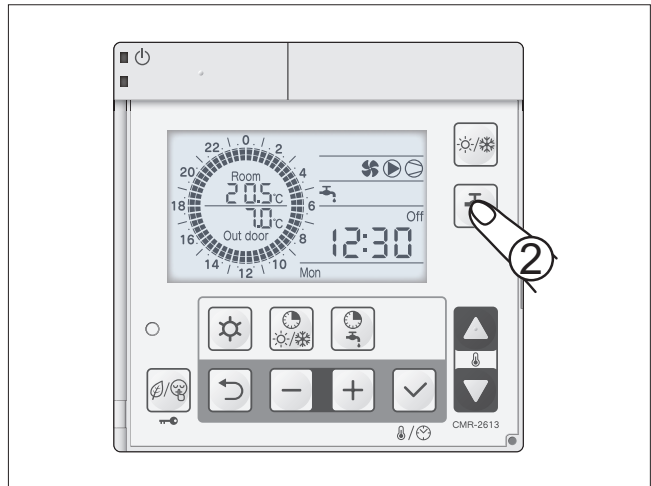

3 Press .

The display shows the  icon.
DHW production Economy set point (par 3112).

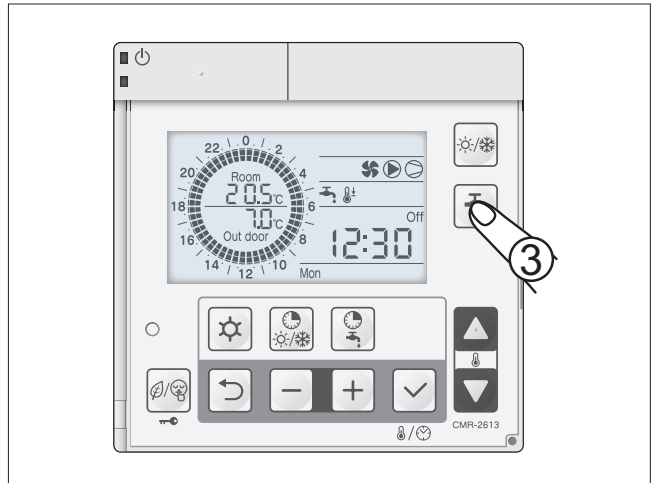

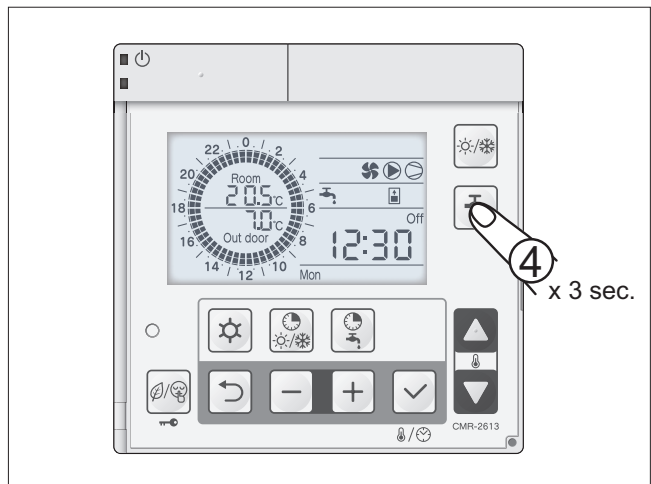

4 Pressing and holding  for 3 sec, enables forced DHW production.

The heat pump works so as to heat the DHW storage tank. The display shows the  icon.



- 4 If an electric heater is fitted in the DHW storage tank, this is activated so as to reach the overboost DHW set point (par 3114).

The display shows the    icon.

WARNING:

The domestic hot water production function must be enabled by setting parameter 3101, and the DHW probe enabled by setting parameter 5109.

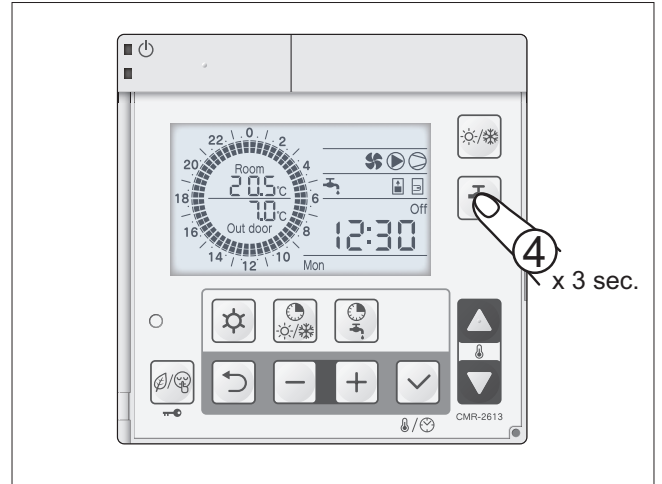

Modifica set-point Acqua Calda Sanitaria

La temperatura dell'acqua calda sanitaria è rilevata dalla sonda posizionata all'interna dell'accumulo sanitario.

To set the Comfort, Economy and Overboost domestic hot water temperature set points, use the following parameters:



Description	Menu	Parameter no.	Default	Value to be set	UOM
Comfort domestic hot water set point	31	11	50	-	0,5°C
Economy domestic hot water set point	31	12	40	-	0,5°C
Overboost domestic hot water set point	31	14	60	-	0,5°C

Installer-level parameters. Follow the instructions described in the paragraph on "Installer-level access" to set the desired set points.

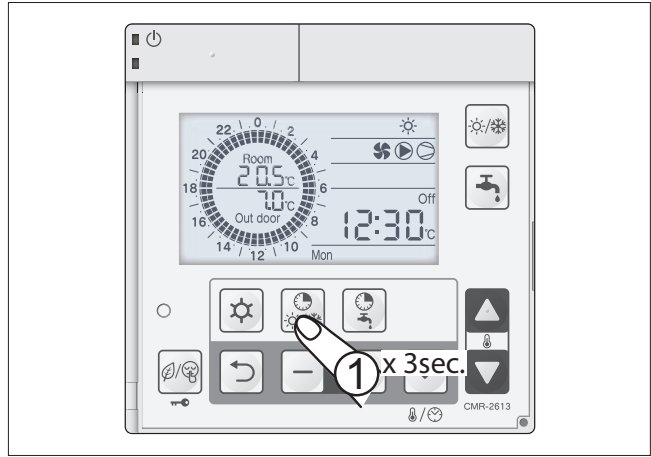

Programming the time bands

1 Press  for 3 seconds to access time band programming.



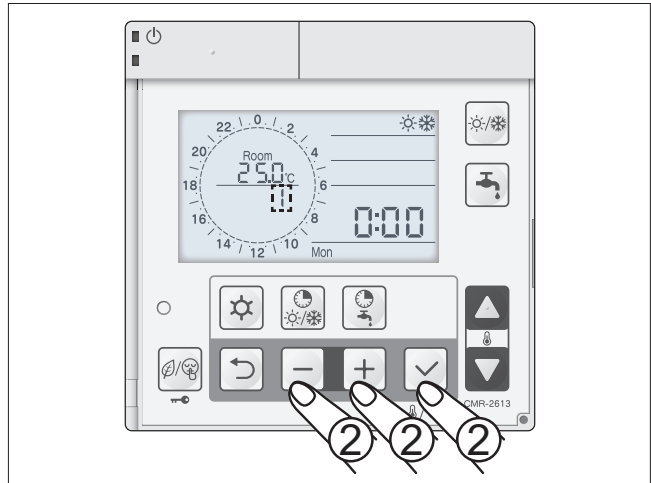

2 Select zone 1 or 2 for programming the time bands by pressing . Confirm by pressing .

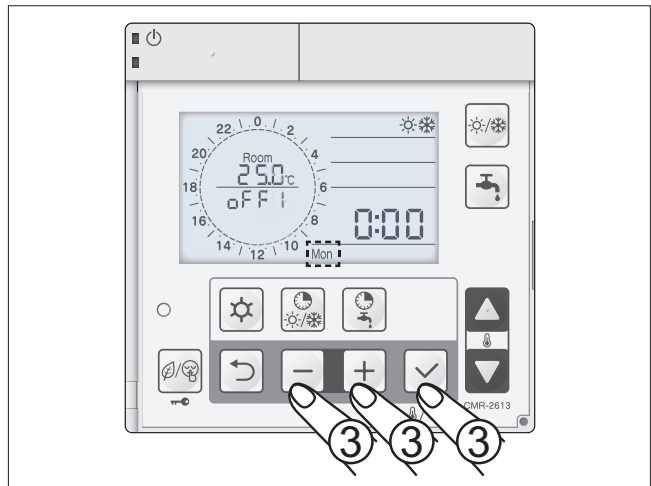

3 Select the day of the week or groups of days* by pressing . Confirm by pressing .

* the time bands can be programmed for each individual day or in groups - 5 weekdays, 2 weekend days or all 7 days.



4 Select whether the time band is ON or OFF by pressing . Confirm by pressing .

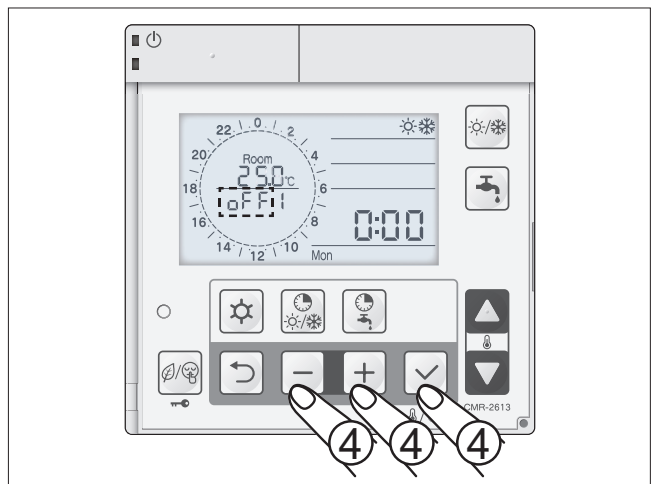

- 5 Set the COMFORT and ECONOMY set point by pressing **- +**.
Confirm by pressing **✓**.

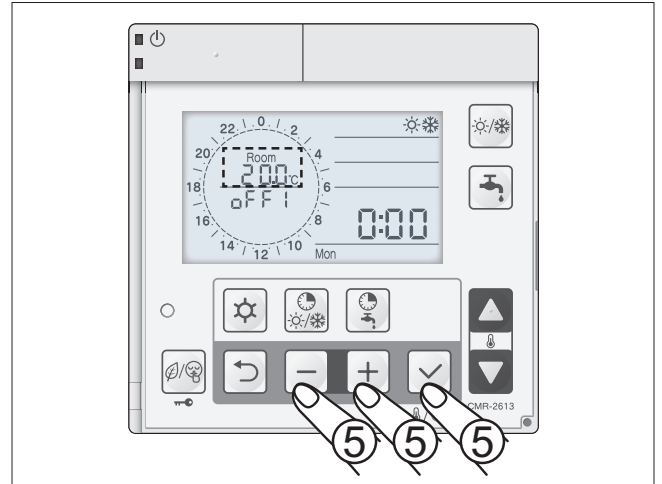
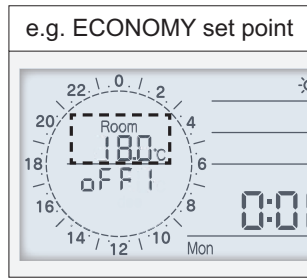
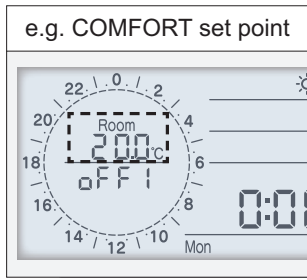

- 6 Time band 1 start COMFORT set point.
Press **- +** to set the time band 1 ON time.
Confirm by pressing **✓**.

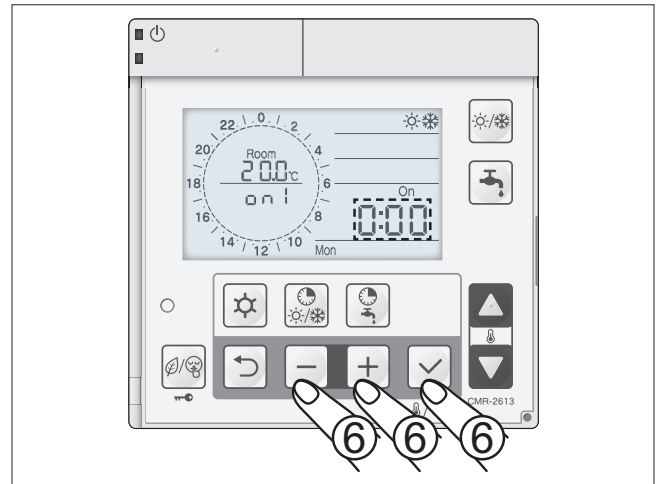

- 7 Time band 1 end COMFORT set point.
Press **- +** to set the time band 1 OFF time.
Confirm by pressing **✓**.

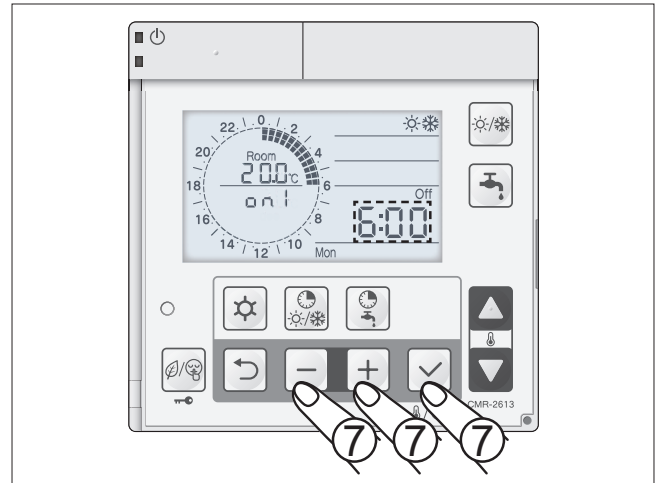

- 8 Time band 2 start COMFORT set point.
Press **- +** to set the time band 2 ON time.
Confirm by pressing **✓**.

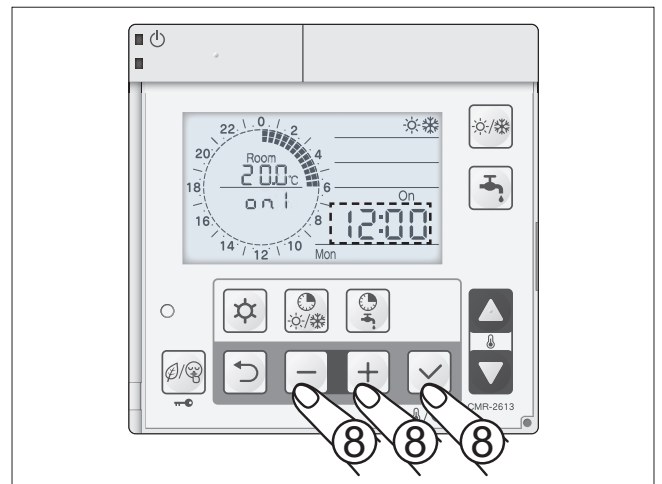

- 9 Time band 2 end COMFORT set point.
 Press **- +** to set the time band 2 OFF time.
 Confirm by pressing **✓**.

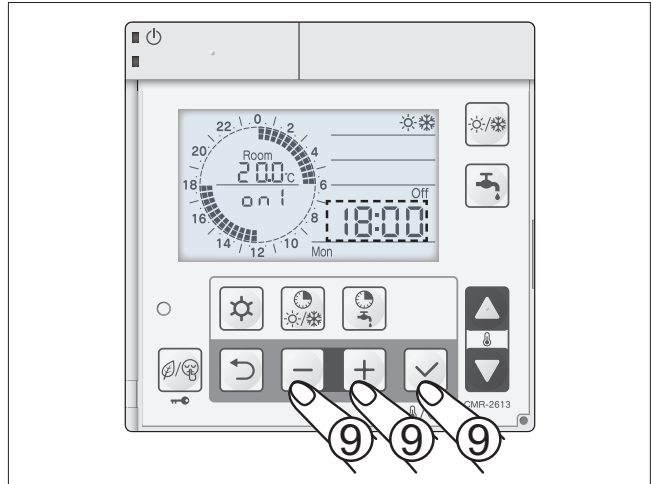

- 10 Repeat the same procedure to set the time band 3 ON/OFF times and for the other days of the week or groups.
 After having set the third time band, the display will show zone "1" or "2". Exit programming mode by pressing **3/8** for 3 seconds.

Time band programming example

Below is an example of a time band program with two temperature levels, Comfort 20°C and Economy 18°C.

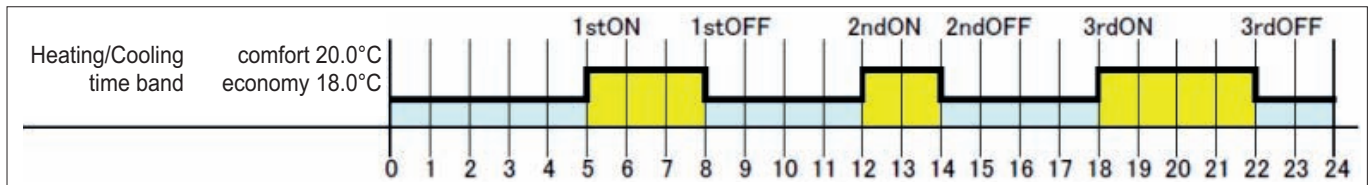

Enabling/disabling the time bands

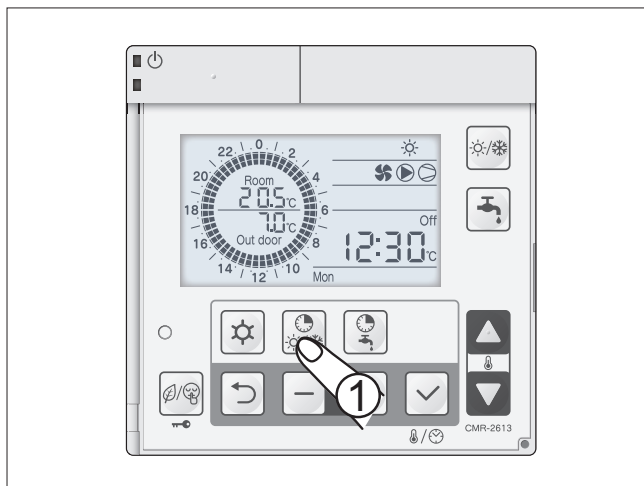

- 1 Press **3/8** to enable or disable the time bands.

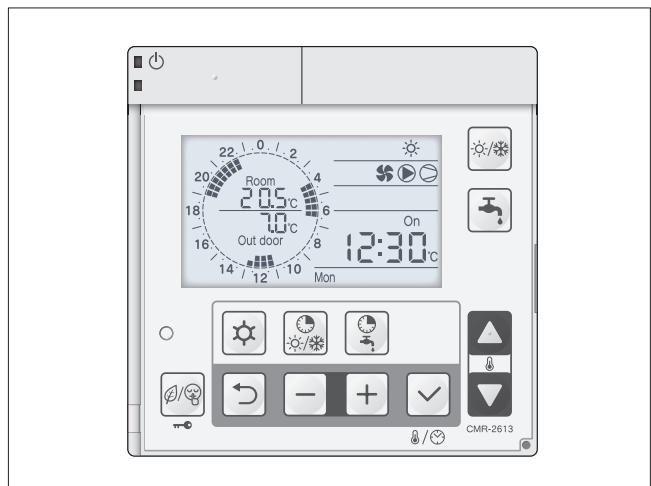





- 2 The display shows the set time bands.

Programming the DHW, Low Tariff and Night Mode time bands



1 Press  for 3 seconds to access time band programming.

The following icons will flash:

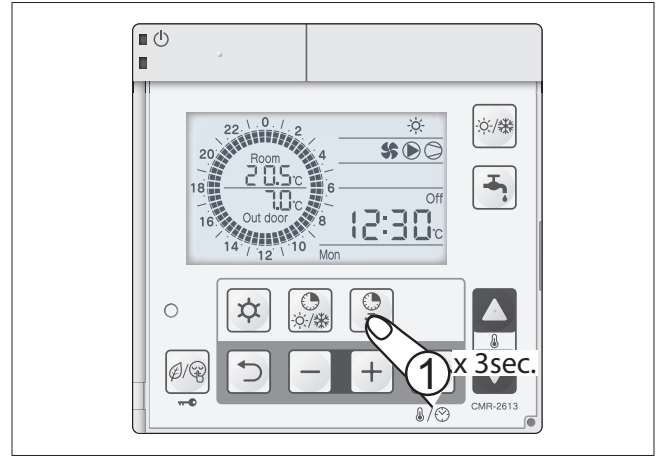

- DHW production 
- Low tariff 
- Night mode 

Press  for 3 seconds to exit programming mode.



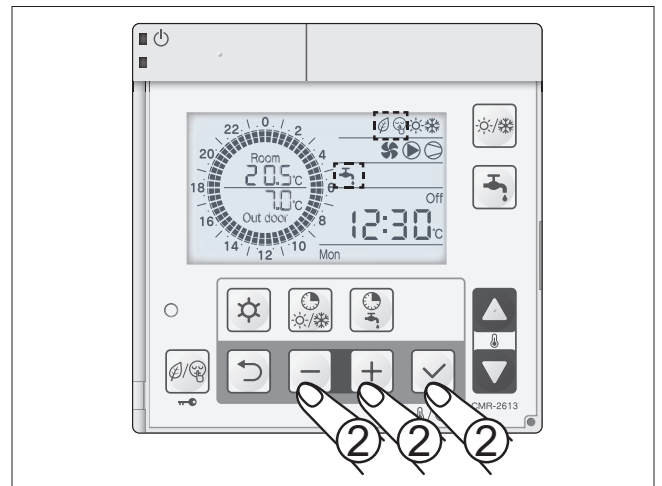



2 Select the mode (DHW, Low Tariff, Night Mode) to be programmed by pressing  . Confirm by pressing .

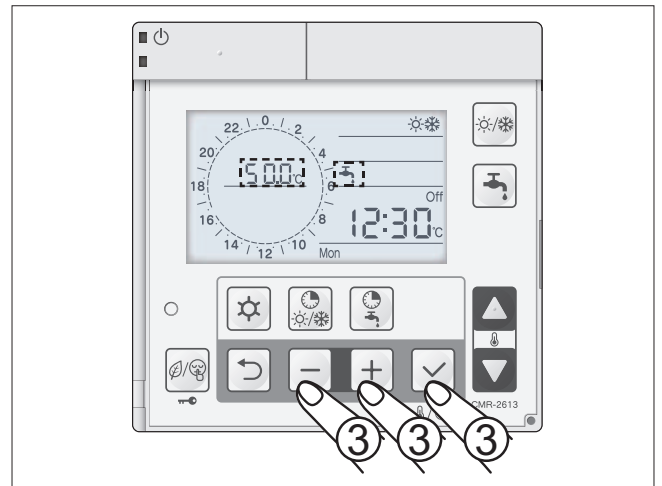
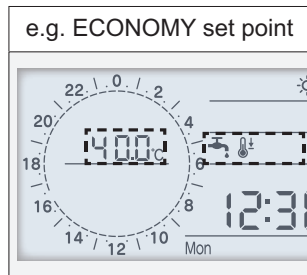
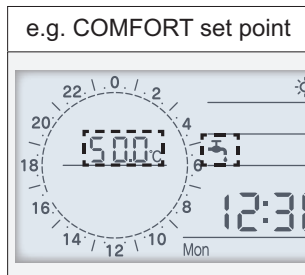

3 Once having selected the mode, set the DHW COMFORT and ECONOMY set points using  . Confirm by pressing .

* Low Tariff and Night Mode do temperature set points.



4 Time band 1 start DHW COMFORT set point. Press   to set the time for DHW COMFORT set point time band 1. Confirm by pressing .

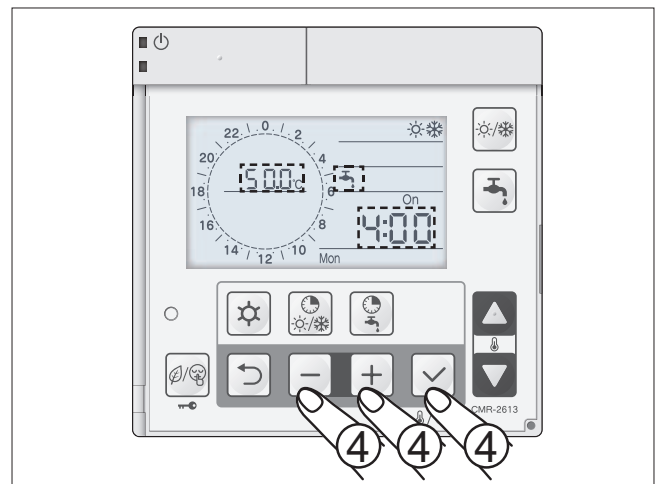

- 5 Time band 1 end DHW COMFORT set point.
 Press **- +** to set the time for DHW COMFORT set point time band 1.
 Confirm by pressing **✓**.

DHW COMFORT set point displayed by the black segment.
 DHW ECONOMY set point displayed by no segment.

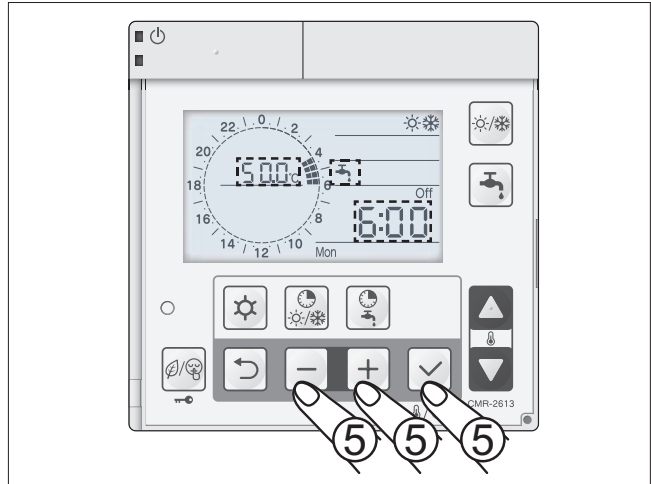

- 6 Time band 2 start DHW COMFORT set point.
 Press **- +** to set the time for DHW COMFORT set point time band 2.
 Confirm by pressing **✓**.

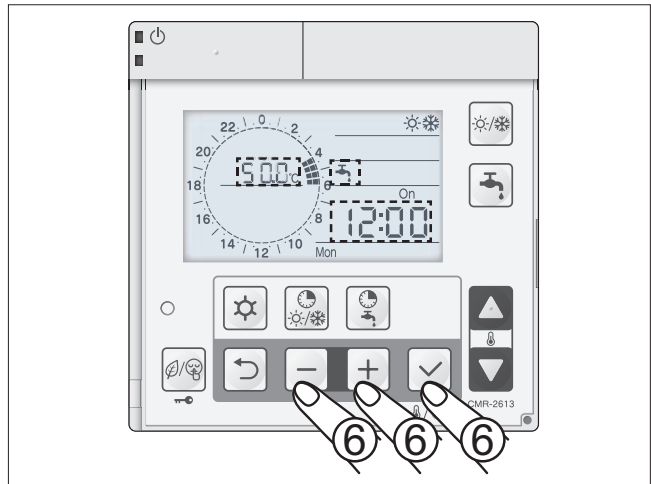

- 7 Time band 2 end DHW COMFORT set point.
 Press **- +** to set the time for DHW COMFORT set point time band 2.
 Confirm by pressing **✓**.

DHW COMFORT set point displayed by the black segment.
 DHW ECONOMY set point displayed by no segment.

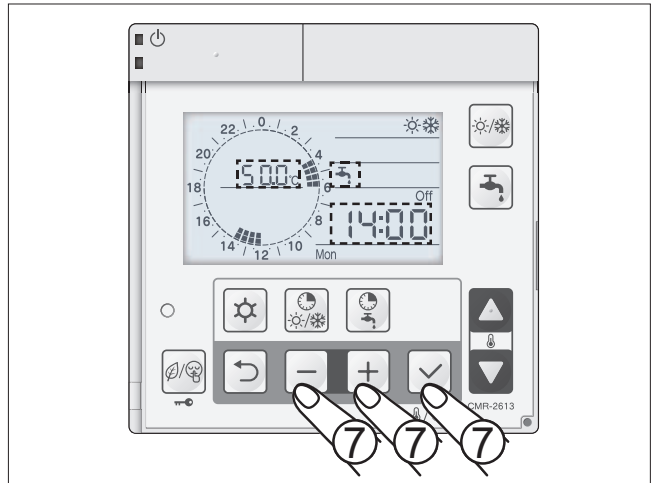

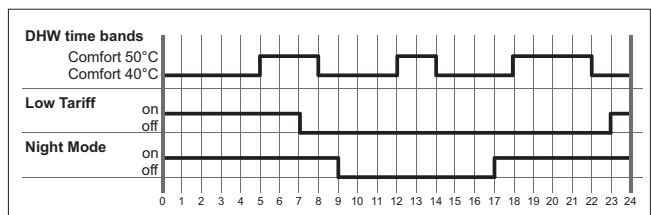

- 8 Repeat the same procedure in 4 and 5 to set time band 3.
 Repeat the same procedure from 2 to 8 to set the time bands for Low Tariff and Night Mode.

Time band programming example for DHW, Low Tariff and Night Mode.
 The time bands are only displayed during programming.
 The DHW, Low Tariff and Night Mode time bands can only be programmed on the Master controller.



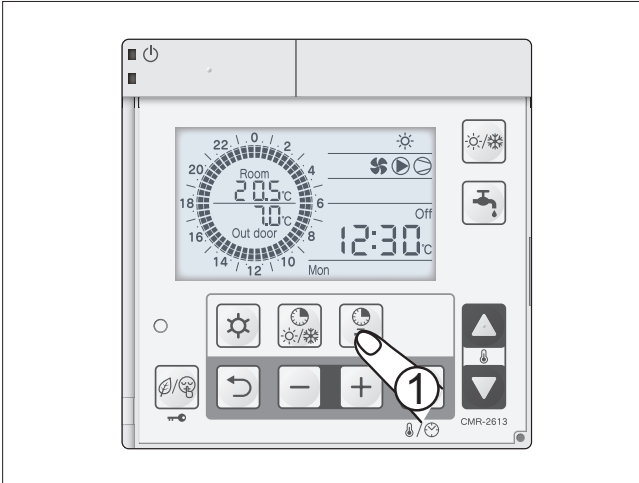



Enabling/disabling the DHW, Low Tariff, Night Mode time bands

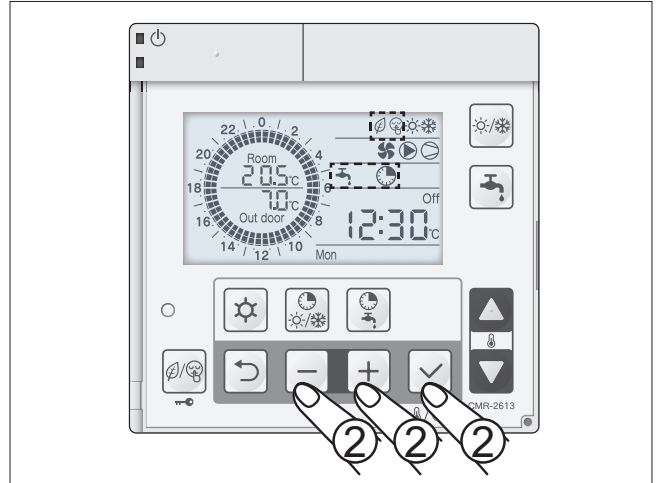

1 Press  to enable or disable the DHW, Low Tariff, Night Mode time bands





2 The display shows that the time bands are enabled by switching on the corresponding icons:

- DHW time bands enabled  
- Low Tariff time bands enabled 
- Night Mode time bands enabled 

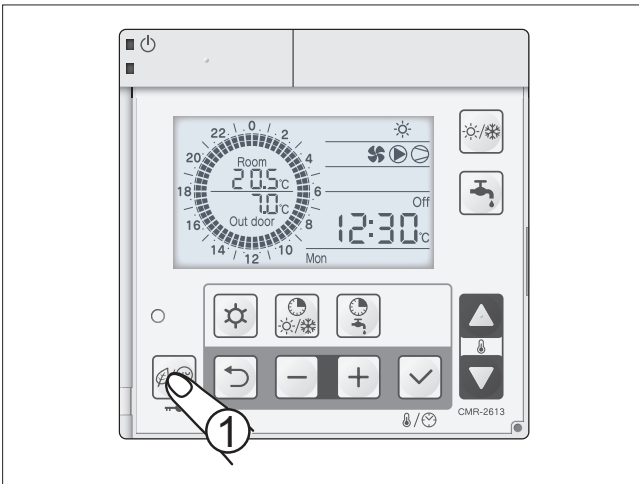
Lock keypad



1 Press  for 3 seconds to lock and unlock the buttons

When the keypad is locked, the unit can still be switched on or switched by pressing ON/OFF 

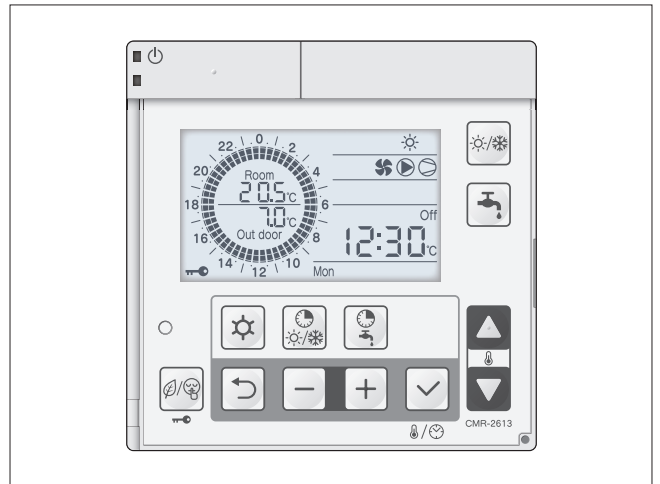

2 The display shows the  icon to confirm that the keypad is locked.

Procedure for accessing and setting the parameters

The parameters are divided into three levels:

- **U** = User
- **I** = Installer
- **S** = Service

User-level access

1 Press  for 3 seconds to access the parameters available to the user.

The display shows the menu code flashing, and the parameter number on steady.

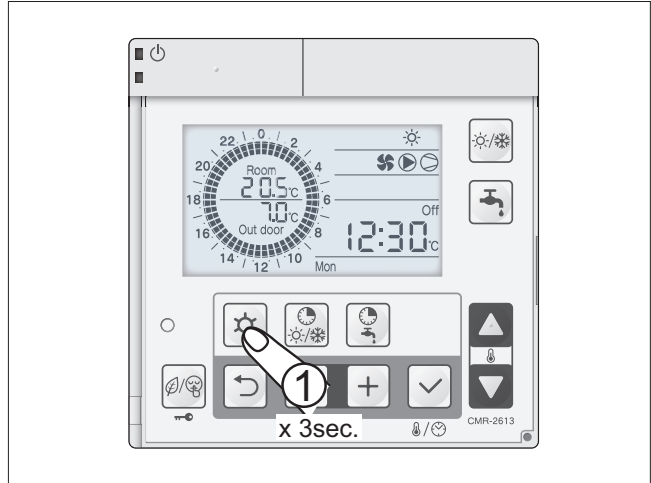
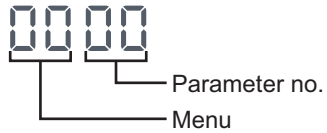

2 Modify the menu code by pressing .

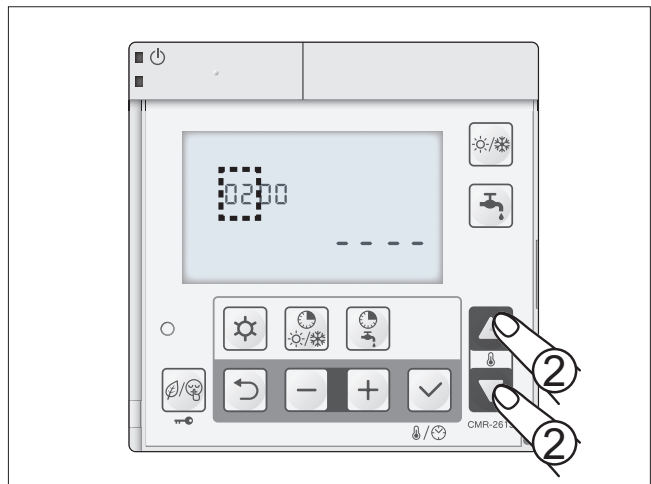



3 Select the parameter no. by pressing .

4 Set the parameter by pressing .

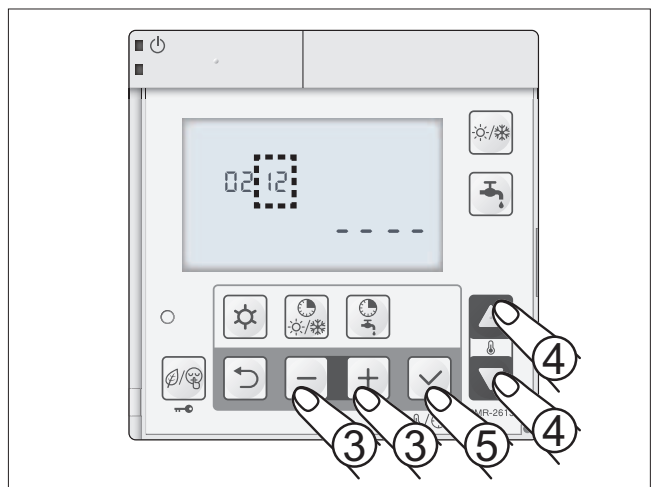

5 Confirm by pressing .



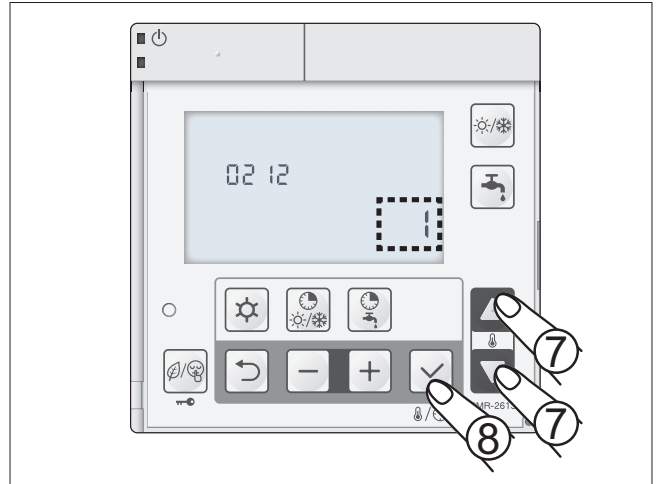



- 6 The parameter value flashes.
- 7 Set the parameter value by pressing .
- 8 Confirm by pressing .
The display shows the parameter number.
- 9 Then set the other parameters by repeating the procedure from 2 to 8, or exit programming mode by pressing  for 3 seconds.



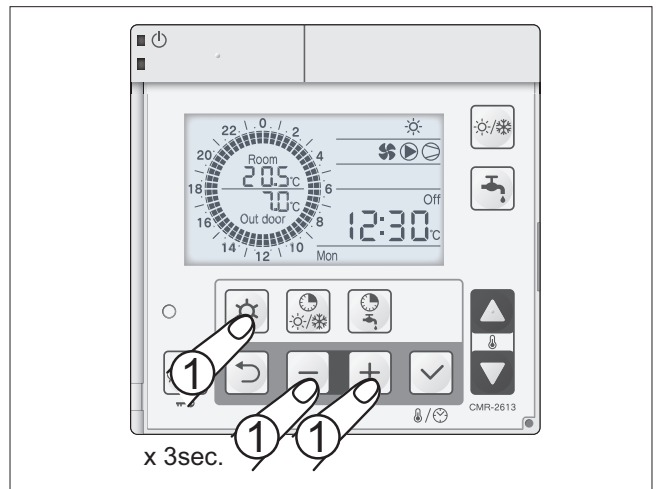
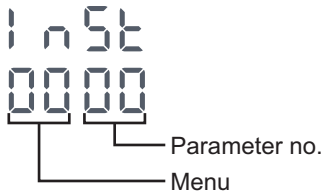

Installer-level access

- 1 Press  +  +  together for 3 seconds to access the installer-level parameters.
The display shows "inst", the menu code flashing, and the parameter number on steady.





- 2 Follow the procedure from 2 to 8 described in the paragraph on User-level access.
- 3 Exit Installer-level programming mode by pressing  +  +  together for 3 seconds.

Service-level access

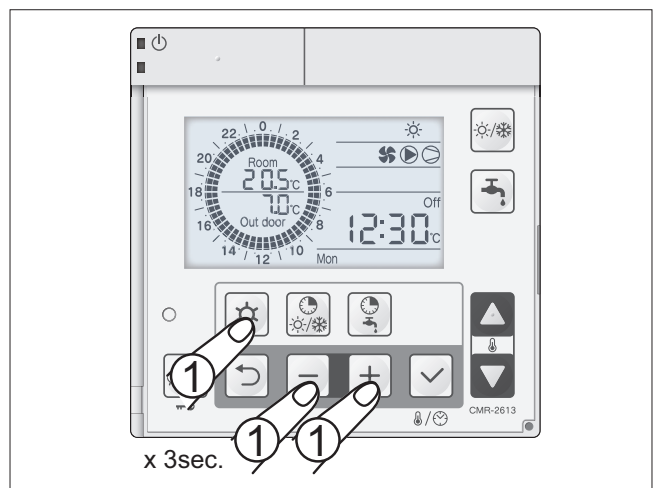
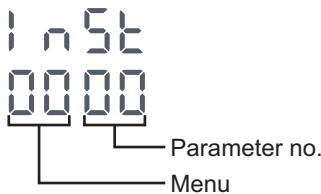
- 1 Press  +  +  together for 3 seconds to access the installer-level parameters.
The display shows "inst", the menu code flashing, and the parameter number on steady.



- 2 Set the menu group and parameter number as 9999, following the procedure from 2 to 5 described in the paragraph on User-level access.
- 3 Set the Service password, following the procedure from 6 to 9 described in the paragraph on User-level access.
- 4 Exit Service-level programming mode by pressing  +  +  together for 3 seconds.

A) Compensation curve

The compensation curve can be set in heating and cooling modes to allow correct heat pump operation depending on the system (radiant panels, fan coils, radiators), thus increasing seasonal efficiency.

To ensure two temperature levels, two compensation curves are available, in both heating and cooling, for low temperature (zone 1) and high temperature systems (zone 2).

List of parameters for setting the compensation curve in heating and cooling:

The probe on the unit (5109 = 0 default setting) is used to measure the outside air temperature. In cases where the air temperature probe on the unit cannot provide a correct temperature reading, use the remote outside air temperature probe (5109 = 1), supplied as an accessory.

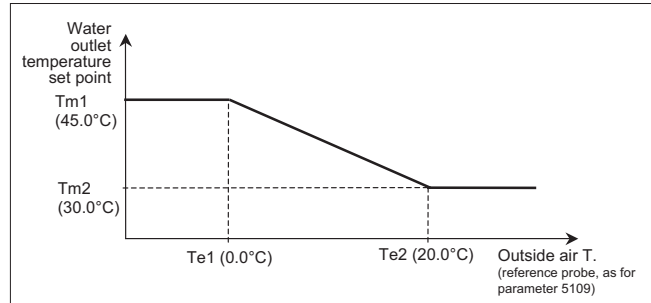

Description	Menu	Parameter no.	Default	Value to be set	UOM
Type of zone 1 set point in heating: <u>0=fixed set point</u> 1=compensation curve	21	0	0	1	-
Max. outlet set point in heating (Tm1), zone 1	21	2	45.0		0,5°C
Min. outlet set point in heating (Tm2), zone 1	21	3	30.0		0,5°C
Minimum outside temperature corresponding to max. outlet temperature (Te1), zone 1.	21	4	0.0		0,5°C
Maximum outside temperature corresponding to min. outlet temperature (Te2), zone 1.	21	5	20.0		0,5°C
Type of zone 2 set point in heating: <u>0=fixed set point</u> 1=compensation curve	21	10	0	1	-
Max. outlet set point in heating (Tm1), zone 2	21	12	45.0		0,5°C
Min. outlet set point in heating (Tm2), zone 2	21	13	30.0		0,5°C
Minimum outside temperature corresponding to max. outlet temperature (Te1), zone 2.	21	14	0.0		0,5°C
Maximum outside temperature corresponding to min. outlet temperature (Te2), zone 2.	21	15	20.0		0,5°C
Type of zone 1 set point in cooling: <u>0=fixed set point</u> 1=compensation curve	21	20	0	1	-
Max. outlet set point in cooling (Tm1), zone 1	21	22	20.0		0,5°C
Min. outlet set point in cooling (Tm2), zone 1	21	23	18.0		0,5°C
Minimum outside temperature corresponding to max. outlet temperature (Te1), zone 1.	21	24	25.0		0,5°C
Maximum outside temperature corresponding to min. outlet temperature (Te2), zone 1.	21	25	35.0		0,5°C
Type of zone 2 set point in cooling: <u>0=fixed set point</u> 1=compensation curve	21	30	0	1	-
Max. outlet set point in cooling (Tm1), zone 2	21	32	20.0		0,5°C
Min. outlet set point in cooling (Tm2), zone 2	21	33	15.0		0,5°C
Minimum outside temperature corresponding to max. outlet temperature (Te1), zone 2.	21	34	25.0		0,5°C
Maximum outside temperature corresponding to min. outlet temperature (Te2), zone 2.	21	35	35.0		0,5°C

Also see the paragraph "Dual set point contact" to enable the compensation curve for zone 2.

B) Heat pump operation with fixed set point.

The heat pump will work in heating and cooling mode based on a fixed set point, set by parameter.

Two fixed set points can be set, in both heating and cooling, for zone 1 and zone 2 respectively.

List of heat pump operating parameters with fixed set point.

Description	Menu	Parameter no.	Default	Value to be set	UOM
HEATING Zone 1: Enable fixed set point 0 = Fixed set point 1 = Compensation curve	21	0	0		-
HEATING Zone 1: Set point	21	1	45.0		0,5°C
HEATING Zone 2: Enable fixed set point 0 = Fixed set point 1 = Compensation curve	21	10	0		-
HEATING Zone 2: Set point	21	11	45.0		0,5°C
COOLING Zone 1: Enable fixed set point 0 = Fixed set point 1 = Compensation curve	21	20	0		-
COOLING Zone 1: Set point	21	21	7.0		0,5°C
COOLING Zone 2: Enable fixed set point 0 = Fixed set point 1 = Compensation curve	21	30	0		-
COOLING Zone 2: Set point	21	31	7.0		0,5°C

Also see the paragraph "Dual set point contact" to enable zone 2.

Relative humidity control in radiant heating/cooling systems

In summer, radiant cooling system must be combined with suitable air dehumidification, in order to ensure indoor comfort and prevent condensation.

Relative humidity can be controlled by connecting a dehumidifier to contact N-45. This will be activated so as to keep maintain humidity set point, as shown on the graph

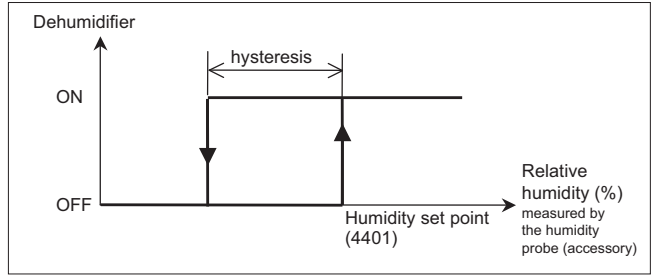

Description	Menu	Parameter no.	Default	Value to be set	UOM
Relative humidity set point	44	01	60	-	1%

Room relative humidity is measured by the humidity probe (accessory), to be connected to contact 17-18 on the heat pump. The probe sends the heat pump controller a 0-10 V signal that is converted into a humidity value, as shown on the graph:

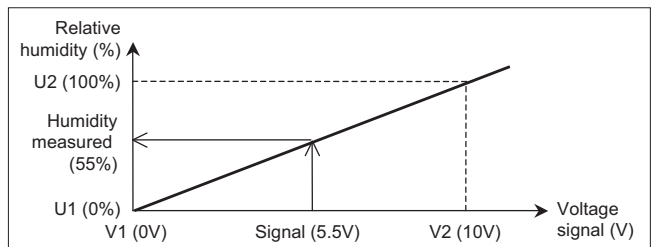

Depending on the 0-10 V humidity probes available on the market, in the event a probe fault, the heat pump displays an alarm if the voltage falls below 0.15 V or exceeds 9.8 V ($\pm 2\%$).

Description	Menu	Parameter no.	Default	Value to be set	UOM
Minimum voltage value (V1)	44	03	0.0	-	0.1V
Maximum voltage value (V2)	44	04	10.0	-	0.1V
Minimum humidity value (U1)	44	05	0	-	1%
Maximum humidity value (U2)	44	06	100	-	1%

Water outlet temperature compensation

The water outlet temperature set point, either calculated according to the compensation curve or fixed, can be compensated according to the maximum relative humidity in the room. The water outlet temperature value can increase so as to avoid possible formation of condensate in radiant cooling systems (underfloor, ceiling, wall, etc.).

If the relative humidity, measured by the humidity probe (accessory), exceeds the value set for parameter 4411, the water outlet temperature set point increases until reaching the maximum outlet temperature.

The maximum outlet temperature is the sum of the cooling set point, calculated according to the compensation curve or fixed, and the value set for parameter 4412.

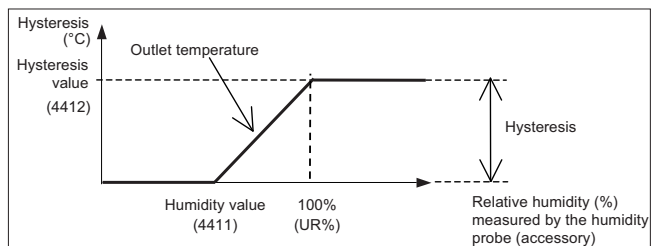

Description	Menu	Parameter no.	Default	Value to be set	UOM
Enable room humidity compensation 0 = Disabled 1 = Enabled	44	10	1	-	-
Room relative humidity value to start increasing the water outlet temperature set point	44	11	55	-	1%
corresponding to 100% relative humidity	44	12	10.0	-	0.5°C

Unit circulator pump operating modes

Operation of the circulator pump can be set by parameter 4200, choosing from the following modes:

- 0) Always ON
- 1) ON/OFF depending on storage tank water temperature
- 2) ON/OFF at intervals set by the “sniffing cycle”

0) Circulator pump always ON

The circulator pump is always on so as ensure a correct system water temperature reading. The circulator pump only stops when the heat pump is switched off using the ON/OFF button or remote contact.

1) Circulator pump ON/OFF depending on storage tank water temperature

This mode can only be set if the storage tank probe (Buffer T. probe) is fitted and enabled, The circulator pump starts (1), together with the compressor, if heating or cooling is required, based on the temperature read by the storage tank probe, so as to reduce pump energy consumption.

(1): the circulator pump on/off delay times are always active.

2) Circulator pump ON/OFF at intervals set by the “sniffing cycle”

On reaching the system water temperature set point, the compressor stops and the system pump is started periodically, in order to minimise energy consumption while guaranteeing a correct temperature reading.

Description	Menu	Parameter no.	Default	Value to be set	UOM
Unit circulator pump operating modes: 0 = Always ON 1 = ON/OFF depending on storage tank water temperature 2 = ON/OFF at intervals set by the “sniffing cycle”	42	00	0	-	-

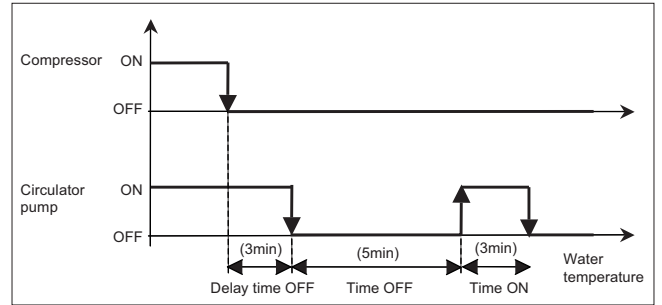

Description	Menu	Parameter no.	Default	Value to be set	UOM
ON time = circulator pump operating time in the “sniffing cycle”.	42	01	3	-	1min
OFF time = circulator pump off time in the “sniffing cycle”.	42	02	5	-	1min
OFF delay time = delay in shutting down the circulator pump after compressor stops when the water temperature set point is reached.	42	03	3	-	1min

Unit circulator pump curve selection

One of three working curves can be selected, depending on pressure drop in the system.

The curves are selected using dipswitches SW5 and SW6 on the installer terminal board:

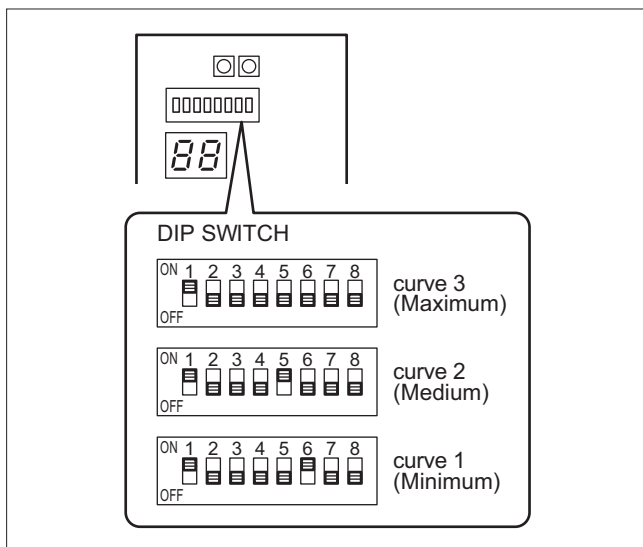

Description	SW 5	SW 6
Curve 3	OFF	OFF
Curve 2	ON	OFF
Curve 1	OFF	ON

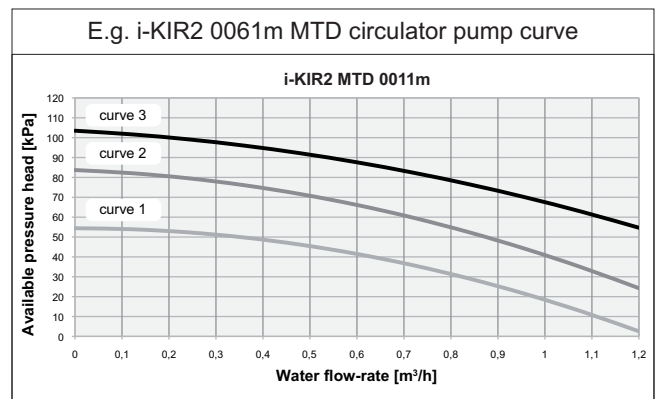

Pump anti-blocking function

The pump on the unit and the pumps in zone 1 and zone 2, if installed, are activated for 5 seconds when the unit is off for at least 48 hours, to prevent mechanical blockage

Frost protection

The frost protection functions are always active, even when the heat pump is OFF from the ON/OFF button or remote contact.

Frost protection based on system water temperature

The frost protection function is active even if the controller is in standby. To prevent the water freezing and damaging the plate heat exchanger, the microprocessor shuts down the compressor and activates the system heat exchanger heater if the temperature measured by the heat exchanger outlet temperature probe is than $+4^{\circ}\text{C}$. The frost prevention temperature set point can only be modified by an authorised service centre, and only after verifying that the water circuit contains antifreeze. Tripping of this alarm shuts down the compressor but not the pump, which remains active.

To reset normal operation, the water outlet temperature must rise to more than: $+7^{\circ}\text{C}$ on the system side. Reset is automatic.

Frost protection based on inside temperature

The heat pump and/or supplementary heat sources (outlet heater or boiler) are activated if the inside room temperature falls below the value set for parameter 4301 = 14°C , so as to prevent the pipes inside the house from freezing, until reaching the water temperature set for parameter 4303 = 35°C .

The pumps in zone 1 and zone 2 are activated together with the pump on the unit if parameter 4340 = 1.

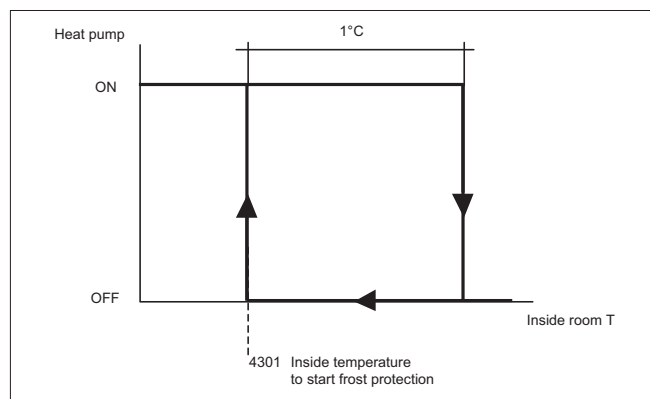

Frost protection based on outside air temperature

The pump on the unit is activated when the outside air temperature falls below the value set for parameter 4311 = 4°C . The backup electric heater, if fitted, is activated if the water temperature is less than 4°C , and is deactivated at 7°C .

The pumps in zone 1 and zone 2 are activated together with the pump on the unit if parameter 4340 = 1.

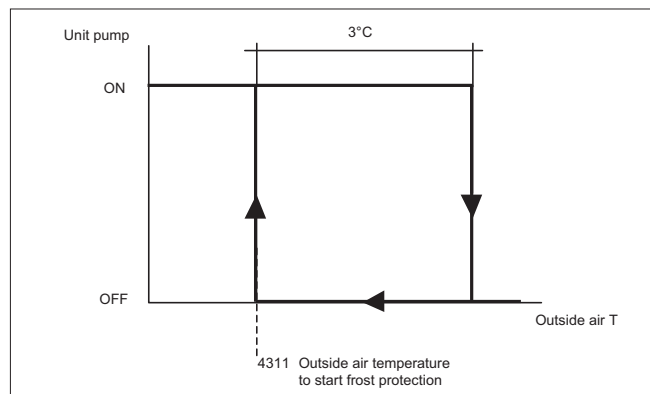

DHW storage frost protection

In order to prevent ice form forming inside the DHW storage tank, the electric heater is activated if the water temperature falls below the value set for parameter 4331 = 5°C and is deactivated at 8°C .

Function available only if present the immersion electric heater in the DHW storage.

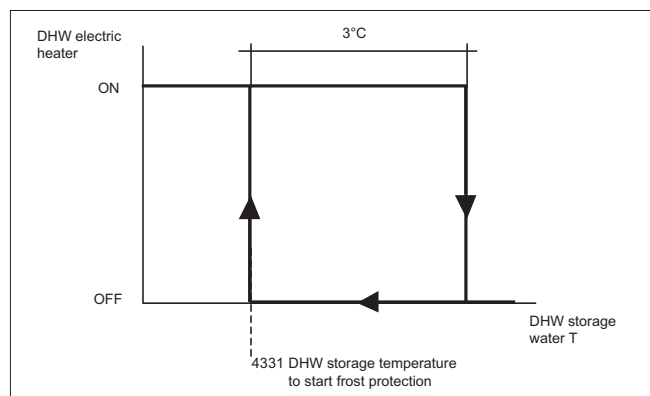

Alarm signals

- 1 When an alarm occurs, the red LED on the ON/OFF button flashes, and the display shows the symbol  and the error code, e.g. **L6**.

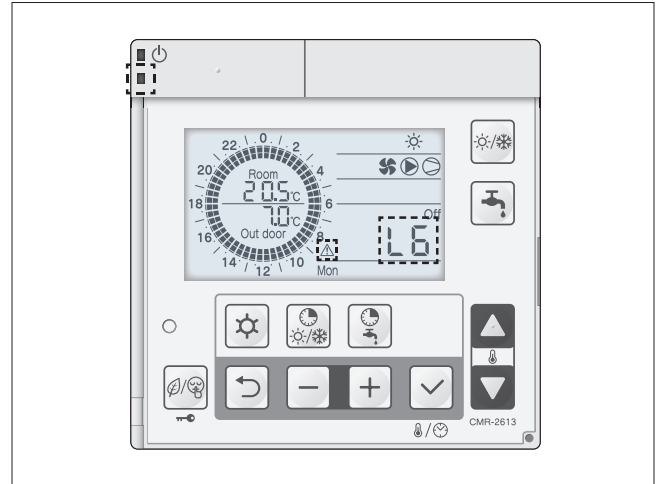

Reset alarms

- 1 Press   together for 3 seconds.

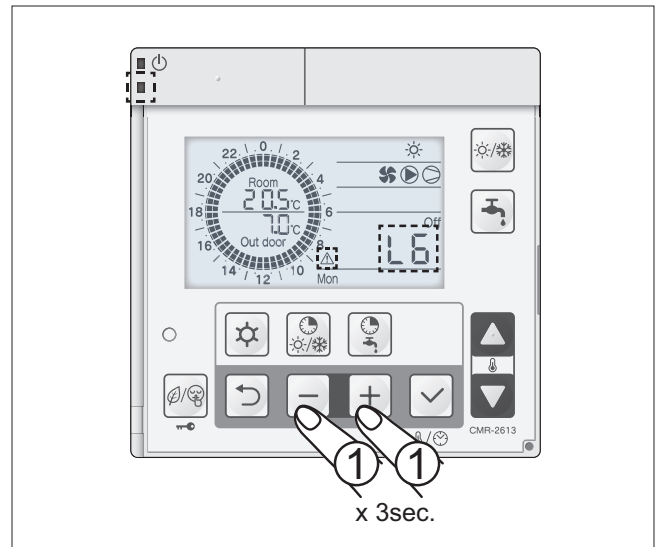

Alarm log

The log of the last 10 alarms can be displayed.

Enter programming mode with Service-level access (see the corresponding paragraph) and check parameters from 0150 to 0160.

To delete the alarm log, set parameter 0161=1.

TABLE ALARMS

ERROR CODE	FEATURES, PARTS, COMPONENTS MALFUNCTIONING	CHECKS	SOLUTION	SIZE	RESET
A0	DC voltage error	FAN MOTOR	Unplug connector 9 and measure the resistance between the red and black wires on the connector. The correct resistance value is above 100kΩ.	0011 0031	Power off
		FUSE CF4 (250V T3.15A)			
		POWER SUPPLY MODULE	Disconnect the terminals (orange and blue) and check the resistance between orange-blue. If the resistance is greater than 100kΩ, the POWER SUPPLY MODULE is normal.	0031	
		POWER SUPPLY	Check power supply	0011-0031	
A1	Outlet temperature error	COMPRESSOR DISCHARGE TEMPERATURE PROBE	Check resistance using a tester [see table 2]	0011 0031	Manual
		COMPRESSOR SUCTION TEMPERATURE PROBE	Check resistance using a tester [see table 1]	0031	
		REFRIGERANT GAS LEAK	Check the service valve and the refrigerant circuit.	0011 0031	
		COMPRESSOR DISCHARGE TEMPERATURE PROBE	Check resistance using a tester [see table 4]	0061	
		COMPRESSOR SUCTION TEMPERATURE PROBE	Check resistance using a tester [see table 3]		
		REFRIGERANT GAS LEAK	Check the service valve and the refrigerant circuit.	0011 0031	
A2	Overcurrent protection Direct current (DC) measurement	ABNORMAL CURRENT DRAW	Check the installation position (intake and outlet air blocked) Check for excessive gas	0011 0031 0061	Manual
		POWER SUPPLY VOLTAGE DROP	Check power supply voltage (230V)	0031 0061	
		MODULE DI POWER	Operate without connecting the compressor connector.	0011 0031 0061	
		FUSE CF2 (250V T15A)	Check electrical continuity of FUSE CF2 (250V T15A) using a tester		
		COMPRESSOR	Other not specified above		
A3	Current transformer disconnected	CONTROL BOARD (PCB-CONTROLLER)	-	0031 0061	Manual
A4	Overcurrent protection Alternating current (AC) measurement	ABNORMAL CURRENT DRAW	Check the installation position (intake and outlet air blocked) Check for excessive gas	0011 0031 0061	Manual
		POWER SUPPLY VOLTAGE DROP	Check power supply voltage (230V)		
		MOMENTARY POWER CUT (IN THE EVENT DI LIGHTNING)	-	Restart operation	
A5	Abnormal COMPRESSOR rotation	INCORRECT OPERATION IN OVERLOAD	Check the installation position (intake and outlet air blocked) Check for excessive gas	0011 0031 0061	Manual
		WATER PUMP BLOCKED WATER CIRCUIT BLOCKED	Check the pump and the water circuit.	0011 0061	
		POWER SUPPLY VOLTAGE DROP	Check power supply voltage (230V)	0011 0031 0061	
		FUSE CF4 (250V T15A)	Check electrical continuity of FUSE CF4 (250V T15A) using a tester	0011	
		FUSE CF2 (250V T15A)	Check electrical continuity of FUSE CF2 (250V T15A) using a tester	0031	
		POWER SUPPLY MODULE	Check the resistance of the POWER SUPPLY MODULE using a tester. Unplug the connector from the compressor and measure the resistance at the ends of the connector six times: between white-black, black-red, red-white respectively and then reversing polarity => If all the measurements are above 100kΩ, the POWER SUPPLY MODULE is working normally	0011 0031	
COMPRESSOR	Other not specified above	Replace the COMPRESSOR			
A6	Return temperature probe error	COMPRESSOR SUCTION TEMPERATURE PROBE	Check resistance using a tester [see table 1]	0031	Automatic
			Check resistance using a tester [see table 3]	0011 0061	
A7	Defrost temperature probe error	DEFROST PROBE	Check resistance using a tester [see table 1]	0031	Automatic
			Check resistance using a tester [see table 3]	0011 0061	
A8	Outlet temperature probe error	COMPRESSOR DISCHARGE TEMPERATURE PROBE	Check resistance using a tester [see table 2]	0031	Automatic
			Check resistance using a tester [see table 4] (*2)	0011 0061	

(*1) While fan motor and/or pump control is active, disconnect the power supply completely and touch the corresponding terminals or connectors.

(*2) If an open circuit is measured on the discharge temperature thermistor, the error screen is displayed 10 minutes after operation commences.
If an open circuit is measured on the discharge temperature thermistor, the error screen is displayed immediately.





ERROR CODE	FEATURES, PARTS, COMPONENTS MALFUNCTIONING		CHECKS	SOLUTION	SIZE	RESET
C0	Power supply module error	POWER SUPPLY MODULE	-	Replace the POWER SUPPLY MODULE	0011 0031 0061	Manual
C2	Outside temperature probe error	OUTSIDE TEMPERATURE PROBE	Check resistance using a tester [see table 1]	Replace the probe if faulty		Automatic
C1	Upper fan motor error (*1)	FUSE CF7 (250V T3.15A)	Check electrical continuity of FUSE CF7 (250V T15A) using a tester	If CF7 is blown, replace the fan motor. If CF7 is not blown, check fan motor voltage. If the voltage is within the standard values, replace the fan motor. If the voltage is not within the standard values, replace the CONTROL BOARD (PCB-CONTROLLER).	0061	Manual
		FAN MOTOR (*1)				
		CONTROL BOARD (PCB-CONTROLLER)				
C3	Lower fan motor error (*1)	FUSE CF6 (250V T3.15A)	Check electrical continuity of FUSE CF6 (250V T15A) using a tester	If CF6 is blown, replace the fan motor. If CF6 is not blown, check fan motor voltage. If the voltage is within the standard values, replace the fan motor. If the voltage is not within the standard values, replace the CONTROL BOARD (PCB-CONTROLLER).	0061	Manual
		FAN MOTOR (*1)				
		CONTROL BOARD (PCB-CONTROLLER)				
C3	Fan motor error (*1)	FUSE CF4 (250V T3.15A)	Check electrical continuity of FUSE CF4 (250V T15A) using a tester	If CF4 is blown, replace the fan motor. If CF4 is not blown, check fan motor voltage. If the voltage is within the standard values, replace the fan motor. If the voltage is not within the standard values, replace the CONTROL BOARD (PCB-CONTROLLER).	0031	Manual
		FAN MOTOR (*1)	Check FAN MOTOR voltage	If the voltage is correct, replace the FAN MOTOR. If the voltage is not correct, replace the CONTROL BOARD (PCB).	0011	
		CONTROL BOARD (PCB-CONTROLLER)				
C4	POWER MODULE temperature increase (above 110°C)	INCORRECT INSTALLATION	Check the installation position (intake and outlet air blocked)	Make sure the position doesn't block the air intake and outlet		Manual
		TEMPERATURE PROBE POWER SUPPLY MODULE		Replace the POWER SUPPLY MODULE		
C5	Power supply module temperature probe error	TEMPERATURE PROBE POWER SUPPLY MODULE	-	Replace the POWER SUPPLY MODULE		Automatic
C6	CONTROL BOARD (PCB-CONTROLLER) error	CONTROL BOARD (PCB-CONTROLLER)	-	Replace the CONTROL BOARD (PCB-CONTROLLER)		Power off
C7	PCB serial interface error	INCORRECT CONTROL BOARD (PCB-CONTROLLER) - WIRING LOOSE PCB INTERFACE CONNECTION CABLE OR CONTACTS	Check loose cable connections and contacts	After having corrected the wiring, restart operation	0011 0031 0061	Automatic
		PCB INTERFACE	Other not specified above	Replace the PCB interface		
		CONTROL BOARD (PCB-CONTROLLER)	Other not specified above	Replace the CONTROL BOARD (PCB-CONTROLLER)		
C8	Printed circuit board (PCB) serial converter error	CONNECTOR 13 INCORRECT CONTACT or POWER SUPPLY MODULE and PRINTED CIRCUIT BOARD (PCB)	Power down, wait around 3 minutes Unplug connector 13 and plug it back in, then power up again	If the same error appears again, replace the POWER SUPPLY MODULE.		Power off
			After having replaced the POWER SUPPLY MODULE, restart operation	If the same error appears again, replace the printed circuit board (PCB).		
CC	Heat pump PCB controller serial error	INCORRECT WIRING [PCB INTERFACE – HEAT PUMP CONTROLLER] OR LOOSE CONTACTS	Check loose cable connections and contacts	Check loose cable connections and contacts. Then restart operation		Automatic
		PCB INTERFACE	Other not specified above	Replace the PCB interface		
		HEAT PUMP CONTROLLER	Other not specified above	Replace heat pump PCB controller		
E4	Water outlet temperature probe error	WATER OUTLET TEMPERATURE PROBE	Check resistance using a tester [see table 1]	Replace the probe if faulty	0031 0061	Automatic
			Check resistance using a tester [see table 5]		0011	
E5	Water return temperature probe error	WATER RETURN TEMPERATURE PROBE	Check resistance using a tester [see table 1]	Replace the probe if faulty	0031 0061	Automatic
			Check resistance using a tester [see table 5]		0011	
FU	High pressure switch activated	AIR CIRCULATION INSUFFICIENT	Check the installation position (intake and outlet air blocked)	Make sure the position doesn't block the air intake and outlet	0061	Power off
		WATER CIRCULATION INSUFFICIENT	Check the temperature difference between water intake and outlet. If the difference is high it means that water flow-rate is too low.	Remove obstructions, clean the water filter and unblock the pump.		
P1	Circulating pump error	CIRCULATING PUMP PRINTED CIRCUIT BOARD (PCB) (*1)	Check pump voltage	If the voltage is within the standard values, the pump does not need to be replaced. If the voltage is not within the standard values, replace the printed circuit board (PCB).	0011 0031 0061	Manual
		WATER PUMP BLOCKED WATER CIRCUIT BLOCKED	Check the pump and the water circuit.	Remove any obstructions, clean the water filter, unblock the pump.		

(*1) While fan motor and/or pump control is active, disconnect the power supply completely and touch the corresponding terminals or connectors.

(*2) If an open circuit is measured on the discharge temperature thermistor, the error screen is displayed 10 minutes after operation commences.
If an open circuit is measured on the discharge temperature thermistor, the error screen is displayed immediately.

ERROR CODE	FEATURES, PARTS, COMPONENTS MALFUNCTIONING		CHECKS	SOLUTION	SIZE	RESET
P3	High pressure switch error	High pressure switch	Check loose cable connections and contacts	If the same error appears again replace the high pressure switch	0061	Power off
UI	High compressor temperature protection error	HIGH COMPRESSOR OPERATING TEMPERATURE PROTECTOR ACTIVATED		Check refrigerant circuit operating pressure/temperature Check refrigerant charge	0011 0031 0061	Manual
L0	Control board EEPROM error	Control board EEPROM		Replace the EEPROM	0011 0031 0061	Power off
L1	DHW storage tank water temperature probe error	DHW STORAGE TANK WATER TEMPERATURE PROBE	Check resistance using a tester	Replace the probe if faulty	0011 0031 0061	Automatic
L2	Outside air temperature probe error	OUTSIDE AIR TEMPERATURE PROBE	Check resistance using a tester	Replace the probe if faulty	0011 0031 0061	Automatic
L3	Storage tank water temperature probe error	STORAGE TANK (BUFFER) WATER TEMPERATURE PROBE ERROR	Check resistance using a tester	Replace the probe if faulty	0011 0031 0061	Automatic
L4	Mixed zone water temperature probe error	MIXED ZONE WATER TEMPERATURE PROBE	Check resistance using a tester	Replace the probe if faulty	0011 0031 0061	Automatic
L5	Humidity probe error	HUMIDITY PROBE	Check resistance using a tester	Replace the probe if faulty	0011 0031 0061	Manual
L6	Flow switch error	FLOW SWITCH ACTIVATED	Check system water flow-rate Check flow switch operation	Check that the filter is clean and check system pressure drop Replace the flow switch	0011 0031 0061	Manual
L7	Low temperature zone error	HIGH MIXED ZONE WATER TEMPERATURE	Check mixing valve operation Check correct setting of compensation curve, fixed set point parameters	Replace the mixing valve Replace the control board	0011 0031 0061	Manual
L8	Air temperature probe error on MASTER remote controller	AIR TEMPERATURE PROBE ON MASTER REMOTE CONTROLLER (ZONE 1)		Replace MASTER remote controller	0011 0031 0061	Manual
L8	Air temperature probe error on SLAVE remote controller	AIR TEMPERATURE PROBE ON SLAVE REMOTE CONTROLLER (ZONE 2)		Replace SLAVE remote controller	0011 0031 0061	Manual
LC	Legionella prevention function	LEGIONELLA PREVENTION FUNCTION NOT COMPLETED CORRECTLY	Check electric heater operation Check correct parameter settings	Replace the electric heater Correct the parameter settings	0011 0031 0061	Manual
740	Communication error on MASTER remote controller	COMMUNICATION FAILURE BETWEEN HEAT PUMP AND MASTER REMOTE CONTROLLER (ZONE 1)	Check electrical connections Check connection cable	Replace MASTER remote controller Replace cable	0011 0031 0061	Automatic
750	Communication error on SLAVE remote controller	COMMUNICATION FAILURE BETWEEN HEAT PUMP AND SLAVE REMOTE CONTROLLER (ZONE 2)	Check electrical connections Check connection cable	Replace SLAVE remote controller Replace cable	0011 0031 0061	Automatic
F5	Control board communication error	COMMUNICATION FAILURE BETWEEN CONTROL BOARD AND MAIN BOARD (INVERTER)	Check electrical connections Check connection cables and connectors	Replace the boards	0011 0031 0061	Automatic
No cooling No heating		4-WAY VALVE	Check resistance using a tester	If the value is not within the standard range, replace the coil	0011 0031 0061	
		OUTSIDE AIR RECIRCULATION	Check air blockages at intake and outlet	Make sure the position doesn't block the air intake and outlet		
		WATER CIRCULATION OUTLET AND RETURN TEMPERATURE PROBE	Check resistance using a tester [see table 1]	If one of these probes is faulty, replace it	0031 0061	
			Check resistance using a tester [see table 5]		0011	
		GAS LEAK	Check the service valve and the refrigerant circuit.	After having repaired the leak, collect all the refrigerant and then recharge to the specified mass	0011 0031 0061	
	WATER CIRCUIT BLOCKED	Check the temperature difference between water outlet and return. If the difference is high it means that water flow-rate is too low.	Remove obstructions, clean the water filter and unblock the pump.			

Display heat pump operating variables on remote controller

- 1 To display the heat pump operating values on the remote controller, press and hold  for 3 seconds.
 - 2 Scroll the parameters by pressing .
 - 3 To display heat pump operating variable press . Press the button  to exit and procedures with the display of other parameter.
- To exit, press  for 3 seconds.

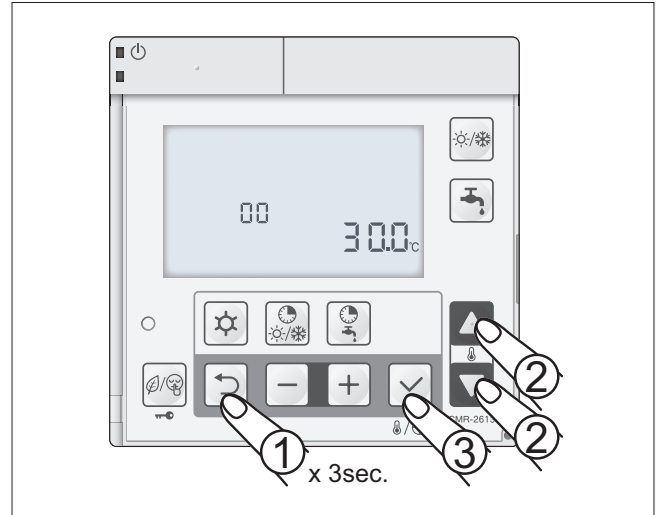

Display heat pump operating variables on display

To display the heat pump operating values on the unit's display, set dipswitch 4 to ON. The data described in the table can then be scrolled by pressing the PUMP SW button.

Monitor	Data Display	Monitor Description	Unit
d0	Water return temperature		1 °C
d1	Compressor operating frequency		1 Hz
d2	Discharge temperature		1 °C
d3	Power consumption		100 W
d4	Fan rotation speed		10rpm
d5	Defrost thermistor temperature		1 °C
d6	Room air temperature		1 °C
d7	Circulator pump speed		10rpm
d8	Suction temperature		1 °C
d9	Water outlet temperature		1 °C

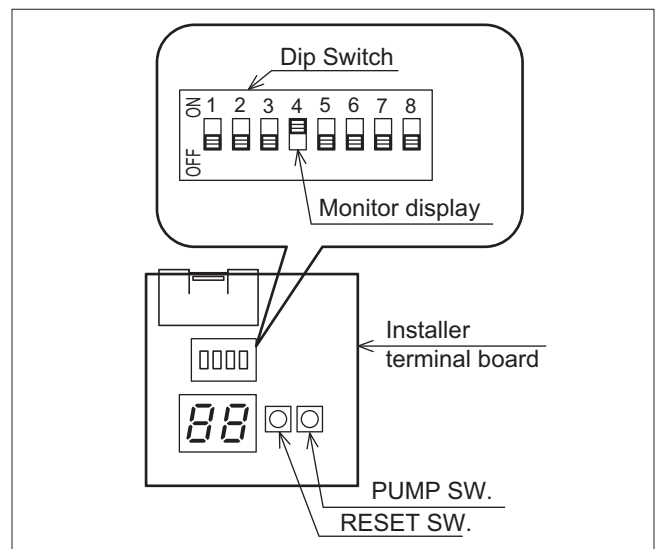

Table 1

Defrost temperature probe (0031m)
 Outside temperature probe
 Suction temperature probe (0031m)
 Water circulation outlet temperature probe

TEMPERATURE (°C)	Resistance (kΩ)
0	31
5	24
10	19
15	15
20	12
25	10
30	8
35	6,7
40	5,5
45	4,6
50	3,8
55	3,2

Table 2

Discharge temperature probe (0031m)

TEMPERATURE (°C)	Resistance (kΩ)
10	1000
20	600
35	300
40	250
50	160
80	50

Table 3

Defrost temperature probe (0011m, 0061m)
 Suction temperature probe (0011m, 0061m)

TEMPERATURE (°C)	Resistance (kΩ)
0	29
5	23
10	19
15	15
20	12
25	10
30	8,3
35	6,9
40	5,7
45	4,8
50	4,1
55	3,4

Table 4

Discharge temperature probe (0011m, 0061m)

TEMPERATURE (°C)	Resistance (kΩ)
10	100
20	64
35	33
40	27
50	18
80	6,4

Table 5

Circuit water outlet and return temperature probe

TEMPERATURE (°C)	Resistance (kΩ)
0	31
10	19
20	12
30	8,1
40	5,5
50	3,8

Resetting alarms displayed by the board on the unit

Press the RESET SW button for 5 seconds to reset the alarm.
The alarms are reset automatically no operations are carried out for 5 minutes.

Alarm log shown by the board on the unit

Press and hold the PUMP SW and RESET SW buttons together for 5 seconds until the log of error codes and the sequential number is shown.
The PUMP SW button is used to select a maximum of 10 past error codes on the display.
If there are no errors saved, the display shows "--".
While an error code is displayed, pressing and holding the reset button for 10 seconds or more resets the alarm log.

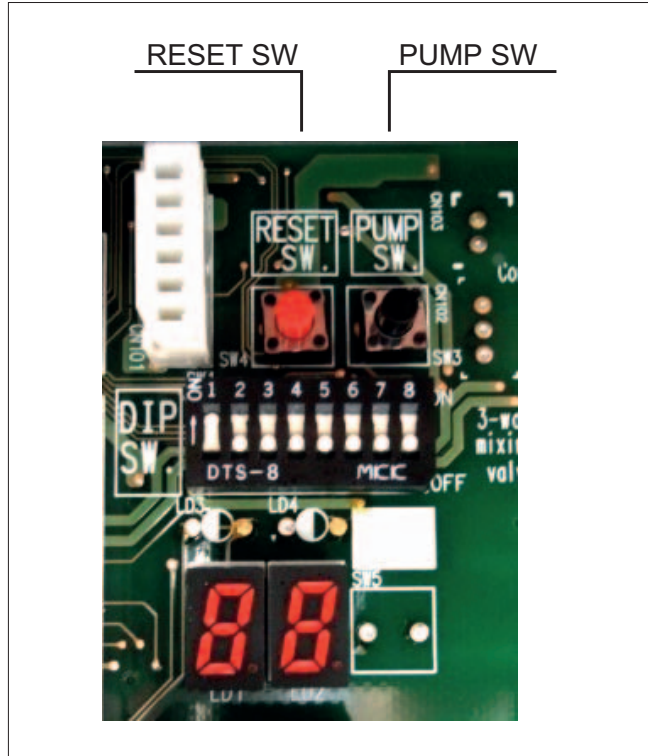

SYSTEM emergency operation

If the heat pump is not working correctly or the compressor has shut down, emergency operation can be activated. Emergency operation allows the water to be heated using the backup electric heater. The compressor remains off. Enable the function by setting parameter 4600 = 2 and select the water temperature set point, parameter 4601 = e.g. 50°C

Description	Menu	Parameter no.	Default	Value to be set	UOM
Backup heater: 0 = disabled 1 = replacement 2 = emergency 3 = supplementary	46	00	2	-	-
Water temperature set point in emergency operation	46	01	50	-	0,5°C

DOMESTIC HOT WATER emergency operation

If the heat pump is not working correctly or the compressor has shut down, emergency operation can be activated. Emergency operation involves heating the domestic hot water using the electric heater inside the storage tank. Enable the function by setting parameter 3102 = 2.

Description	Menu	Parameter no.	Default	Value to be set	UOM
0 = Heat pump + Electric heater 1 = Heat pump only 2 = Electric heater only	31	02	2	-	-

SHUTTING DOWN FOR LONG PERIODS

After deactivating the heat pump:

- Disconnect the unit from the power supply.
- Make sure the remote keypad is in the "OFF" position.
- Place QF1 in the OFF position (see wiring diagram).
- Deactivate the indoor terminal units by placing the switch of each unit in the "OFF" position.
- Close the water valves.

⚠ If the outside temperature may fall below zero; there is the risk of freezing.
The water circuit **MUST BE EMPTIED AND CLOSED** (if draining after operation in heat pump mode, beware that

the water may be hot), or antifreeze must be added in the proportion recommended by the manufacturer. It is recommended to use non-toxic food grade antifreeze, compliant with the standards in force in the countries where the unit is used, if domestic hot water production is also featured.
If the mains switch is turned to "off" for more than four hours, after turning it on and before reactivating the unit, leave the power on but the unit deactivated for at least two hours to preheat the oil in the compressor sump.

Never perform any cleaning operations before having disconnected the unit from the mains power supply.

Make sure power is not connected before proceeding.

Control maintenance is fundamental to maintain the efficiency of the unit both in terms of operation and energy consumption. The Technical Service maintenance plan must be observed, with an annual service which includes the following operations and checks:

- Filling of the water circuit;
- Presence of air bubbles in the water circuit;
- Efficiency of safety devices;
- Power supply voltage;
- Electrical power input;
- Tightness of electrical and water connections;

- Condition of the compressor contactor;
- Efficiency of the plate heat exchanger resistor;
- Verification of operating pressure, superheating and subcooling
- Efficiency of the compressor heater
- Cleaning of the finned coil every three months
- Cleaning of the fan grills
- Cleaning of condensate drain pan.
- Cleaning of water filters.
- Checking the ventilation openings on the base are free of leaves, bushes or anything else that may obstruct air flow.

For units installed near the sea, the intervals between maintenance should be halved.

UNSCHEDULED MAINTENANCE

Never perform any cleaning operations before having disconnected the unit from the mains power supply.

Make sure power is not connected before proceeding.

CHEMICAL WASHING

It is recommended to chemically flush the plate heat exchanger after every 3 years of operation.

To perform this operation, contact a specialist technician.

REFRIGERANT GAS CHARGE

The chillers are filled with R410A refrigerant gas and tested in the factory. In normal conditions, there should be no need for the Technical Service to intervene to check the refrigerant gas. However, over time, small leaks may develop at the joints leading to loss of refrigerant and draining of the circuit, causing the unit to function poorly.

In this case, the leaks of refrigerant must be identified and repaired and the refrigerant circuit recharged.

Proceed as follows:

- Empty and dry the entire refrigerant circuit using a vacuum pump connected to the low and high pressure tap until the vacuumometer reads about 10 Pa.
Wait a couple of minutes and check that this value does not rise to more than 50 Pa.
- Connect the refrigerant gas cylinder or a filling cylinder to the low pressure line pressure gauge connection
- Charge the quantity of refrigerant indicated on the unit's rating plate.

- Always check the superheating and subcooling values, which should be between 5 and 10°C and 4 and 8°C.
- After a couple of hours operation, check that the liquid indicator indicates a dry circuit (dry-green).

⚠ In the event of partial leaks, the circuit must be completely emptied before being recharged.

The R410A refrigerant must only be charged in the liquid state.

Operating conditions other than rated conditions may produce considerably different values.

Tightness testing or identification of leaks must only be carried out using R410A refrigerant gas, checking with a suitable leak detector.

The refrigerant circuit **must not be charged** with a refrigerant other than that indicated on the rating plate and in this manual.

The use of a different refrigerant may cause serious damage to the compressor.

- Oxygen, acetylene or other flammable or poisonous gases **must never be used** in the refrigerant circuit as they may cause explosion or poisoning.

Oils other than those indicated **must not be used**.

The use of different oil may cause serious damage to the compressor.

DISPOSAL

The unit must be disposed of according to the legislation in force in the country concerned

USEFUL INFORMATION

For information on technical assistance and obtaining spare parts, contact

CLIMAVENETA S.P.A.

AFTER SALES DEPARTMENT - RESIDENTIAL BUSINESS

Via Duca d'Aosta 121 - 31031 Mignagola di Carbonera (TV) ITALY

Tel: +39.0424.509500

Fax: +39.0424.509563

www.climaveneta.com - info@climaveneta.com

Installer: _____ Designer: _____

Type of application: _____

Street _____ number _____

City/town _____ Postcode/ZIP code _____ Province/State _____

Unit model installed _____ Serial number _____

Is there a system design? YES NO If YES, has the system been developed completely in accordance with the design? YES NO

Installation date: _____

Systems included:

- Winter heating AT (radiators)
- Winter heating MT (fan coil)
- Winter heating BT (radiant panels)
- Summer cooling
- DHW production
- Solar thermal installed

Mark the type of system installed and describe the components in the corresponding tables

Heating system circuit

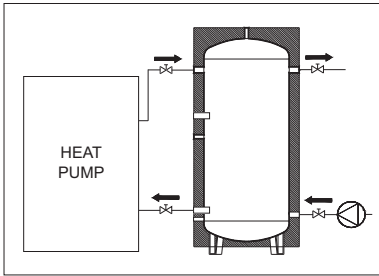

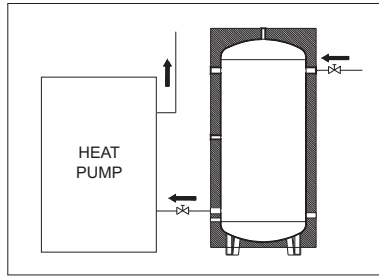

	Storage tank	Additional expansion vessel
Volume [l]		
Type/model		
	Secondary pump	
Installed?		
Type/model		

Hot water set point: _____ °C

Cold water set point: _____ °C

Domestic hot water circuit

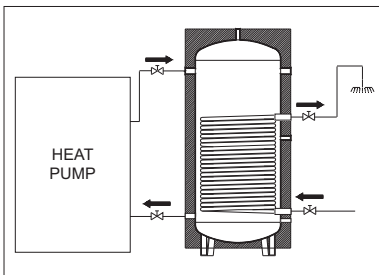

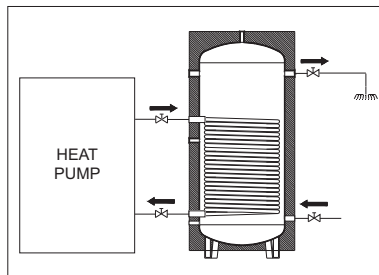

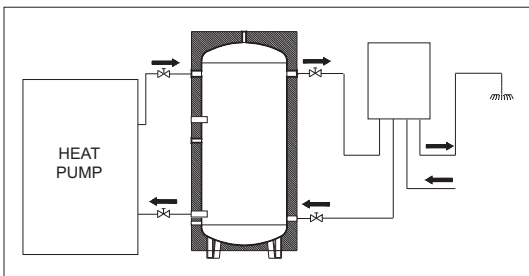

	Storage tank with coil	Storage cylinder	Expansion vessel
Volume [l]			
Type/model			
Coil water volume [l]			
Coil heat exchange area [m ²]			

Domestic hot water set point: _____ °C

CONCERNING UNIT INSTALLATION OPERATIONS AND SETUP FOR COMMISSIONING

HAVE THE FOLLOWING CHECKS BEEN COMPLETED?

Components installed (as described in the paragraph on "Water circuit connections")	YES	NO
• Two pressure gauges with a suitable scale are installed on the inlet and outlet	<input type="checkbox"/>	<input type="checkbox"/>
• Shut-off valves are installed on the heating system circuit and domestic hot water circuit inlet and outlet	<input type="checkbox"/>	<input type="checkbox"/>
• Two thermometers are installed, on the inlet and outlet	<input type="checkbox"/>	<input type="checkbox"/>
• All pipes are insulated with suitable vapour barrier material to prevent formation of condensate and heat loss, with control and shut-off devices protruding from the insulation	<input type="checkbox"/>	<input type="checkbox"/>
• Drain valves are installed at the lowest points in the system	<input type="checkbox"/>	<input type="checkbox"/>
• Automatic or manual air vent valves are installed at the highest points in the system	<input type="checkbox"/>	<input type="checkbox"/>
• An additional expansion vessel is installed on the system if the standard vessel is insufficient	<input type="checkbox"/>	<input type="checkbox"/>
• Vibration damper joints are installed on the inlet and outlet water pipes	<input type="checkbox"/>	<input type="checkbox"/>
• A low-loss header is installed if the water content is insufficient	<input type="checkbox"/>	<input type="checkbox"/>
• Vibration damper supports are installed on the unit	<input type="checkbox"/>	<input type="checkbox"/>
• The domestic hot water production system is installed	<input type="checkbox"/>	<input type="checkbox"/>
• The safety valve is installed and suitably sized	<input type="checkbox"/>	<input type="checkbox"/>
• The domestic hot water expansion vessel is installed and suitably sized	<input type="checkbox"/>	<input type="checkbox"/>

Checks (as described in the paragraph on "Checking and starting up the unit")	CHECKED
• Two pressure gauges with a suitable scale are installed on the inlet and outlet	<input type="checkbox"/>
• The unit is positioned as described in the chapter on "Positioning" in this manual	<input type="checkbox"/>
• The filter is installed on the system return/inlet as close as possible to the unit and in a position that is easy to access for maintenance. REQUIRED component, this must be installed before water circulates through the heat exchanger otherwise the warranty will be void	<input type="checkbox"/>
• The filter is installed on the domestic hot water return/inlet as close as possible to the unit and in a position that is easy to access for maintenance. REQUIRED component, this must be installed before water circulates through the heat exchanger otherwise the warranty will be void	<input type="checkbox"/>
• (Water-to-water units only) The filter is installed on the source return/inlet as close as possible to the unit and in a position that is easy to access for maintenance. REQUIRED component, this must be installed before water circulates through the heat exchanger otherwise the warranty will be void	<input type="checkbox"/>
• The flow switch is installed on the unit's outlet to the heating system circuit and is electrically connected. REQUIRED component, this must be installed before water circulates through the heat exchanger otherwise the warranty will be void	<input type="checkbox"/>
• (Water-to-water units only) The flow switch is installed unit's outlet to the source circuit and is electrically connected. REQUIRED component, this must be installed before water circulates through the heat exchanger otherwise the warranty will be void	<input type="checkbox"/>

Checks (as described in the paragraph on "Checking and starting up the unit")

CHECKED

- The connection pipes are suitably supported so that these do not weigh on the appliance
- Correct sizing of the expansion vessel has been verified according to the system water content and the expected operating temperature
- The position of the outside air temperature probe complies with the information provided in the installation manual
- The position of the room controllers installed complies with the information provided in the installation manual
- The position of the DHW storage tank probe complies with the information provided in the installation manual
- (Units with heat recovery only) The non-return valve is fitted on the domestic hot water circuit
- All safety conditions have been respected
- The unit is fixed to the surface it rests on
- Water connections have been carried out as indicated in the installation manual
- All water connections are tight
- All electrical connections are tight
- Make sure the water circuit has been washed and drained
- There is no air in the system (vent if necessary)
- The valves on the water circuit are open
- Electrical connections have been carried out correctly
- Voltage is within a tolerance of 10% of the rated voltage for the unit
- Unbalance between phases is less than 2%, for three-phase units
- Maintenance clearances comply with the specifications in the Installation manual under the section on POSITIONING
- Power supply electrical complies with the data on the rating plate and specified in the Installation manual under the section on MAINS POWER SUPPLY CONNECTION
- The system water content complies with the specifications in the Installation manual under the section on WATER CONNECTIONS
- Suitable water flow-rate for operation of the entire unit is guaranteed as specified in the Installation manual under the section on WATER CONNECTIONS
- (Air-to-water units only) The system has been protected with antifreeze, respecting the quantities shown in the Installation manual under the section on WATER CONNECTIONS
- The DHW storage tank has been fitted with an electric heater for Legionella prevention

It is hereby declared that the site and access to the site where the unit to be operated or serviced is installed has been made safely accessible in compliance with all safety standards specified by Italian law 81/08 in force. A supervisor must be present on site to inform workers of residual risks in the workplace.

WARNING:

Failure to complete commissioning due to causes not attributable to the unit will require a second visit, to be charged to the customer directly by the local service centre.

Installer's signature _____

Date _____

Climaveneta S.p.A.

Via Sarson 57/c
36061 Bassano del Grappa (VI)
Italy
Tel +39 0424 509 500
Fax +39 0424 509 509
info@climaveneta.com
www.climaveneta.com

Climaveneta France

3, Village d'Entreprises
ZA de la Couronne des Prés
Avenue de la Mauldre
78680 Epône
France
Tel +33 (0) 1 30 95 19 19
Fax +33 (0) 1 30 95 18 18
info@climaveneta.fr
www.climaveneta.fr

Climaveneta Deutschland GmbH

Lyrenstraße 13
44866 Bochum
Germany
Tel +49 2327-95428-0
Fax +49 2327-95428-99
info@climaveneta.de
www.climaveneta.de

Climaveneta España - Top Clima

Londres 67, 1 4
08036 Barcelona
Spain
Tel +34 934 195 600
Fax +34 934 195 602
topclima@topclima.com
www.climaveneta.com

Climaveneta Chat Union**Refrig. Equipment Co Ltd**

88 Bai Yun Rd, Pudong Xinghuo
New dev. zone 201419 Shanghai
China
Tel 008 621 575 055 66
Fax 008 621 575 057 97

Climaveneta Polska Sp. z o.o.

Ul. Sienkiewicza 13A,
05-120 Legionowo,
Poland
Tel +48 22 766 34 55-57
Fax +48 22 784 39 09
info@climaveneta.pl
www.climaveneta.pl

Climaveneta Climate Technologies (P) Ltd

#3487, 14th Main, HAL 2nd stage,
Indiranagar, Bangalore 560008
India
Tel: +91-80-42466900 - 949,
Fax: +91-80-25203540
sales@climaveneta.in

Climaveneta Powermaster Ltd.

Unit 6, St Clare Business Park
Holly Road - Hampton Hill
Middlesex - TW12 1PZ
U.K.
Tel: +44 (0) 20 8783 1008
Fax: +44 (0) 20 8783 1009
response@climaveneta.co.uk
www.climaveneta.co.uk