

KÖNNEN 创能

AIR SOURCE HEAT PUMP WATER HEATER FOR HOT WATER & SPACE HEATING D01H & D02H & D03H Series



ZHEJIANG CEN NEW ENERGY TECHNOLOGY CO., LTD

Address : Sanlian Industrial Zone, Yucheng Town, Haiyan, Zhejiang, China
Tel : +86-573-86226069 / 86226073
Fax : +86-573-86226079
E-mail : cen_heatpump6@cn-xny.com.cn
Web : www.konnen.com.cn

Applications

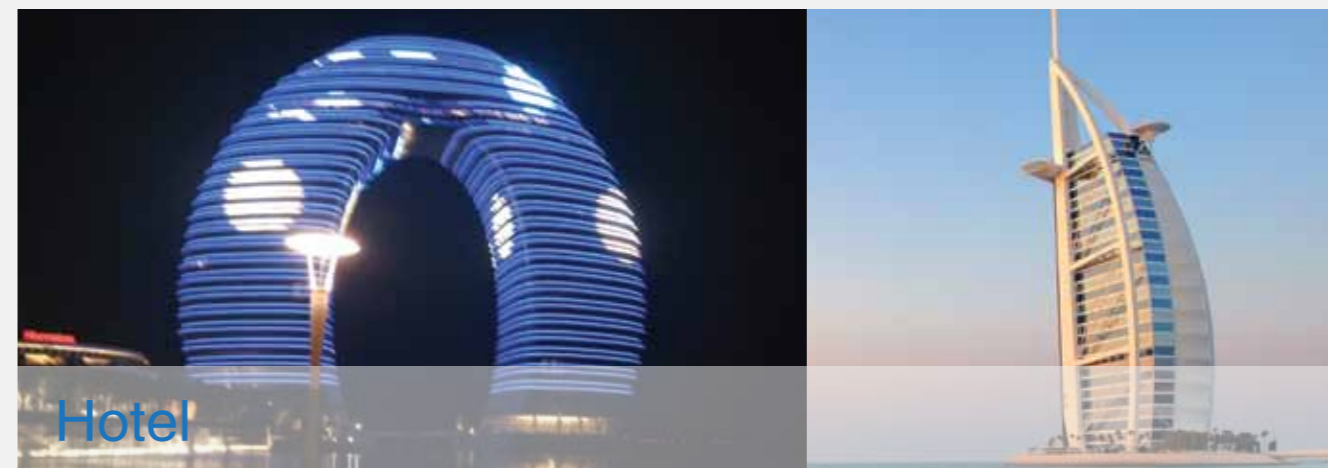

COMPANY PROFILE

Zhejiang CEN New Energy Technology Co., Ltd., is a professional heat pump factory combines R&D, manufacture, installation, trade, and after-sales of heat pumps, with complete performance 25H/P laboratory.

Our main products are air source heat pumps for home and commercial use, ground/water source heat pumps, combine cooling heating & hot water heat pumps, swimming pool heat pumps, etc.

We cooperate with first-class national academic institutions, established the heat pump research and development center, the laboratory, and testing center. With more than 25 engineers working on heat pump design, research and optimization.

Our laboratory can imitate different ambient conditions between -20°C to 50°C , to get the complete parameters from testing. Precise experiments make sure that our product design is reasonable, safe and stable.

We also have a professional installation team, which offers the best solution for installation, and instructions for after-sales. Our aim is to produce high quality product with our best service, and to grow up with our clients. Let's together create a win-win business relationship, and a more prosperous future!

Product Features

Use stainless steel 304 material for heat exchanger side cover, fastener and other important parts etc.. Not easy to rust and corrosion, more durable.



Heat resistance and cold resistance alloy blades, efficient inner rotor motor; Big air volume, low noise, high efficiency.

Environmental protection refrigerant: protect atmospheric ozone layer, small pressure loss, stronger heating capacity, better heat transfer performance.

System main loop and spray circuit both adopt high precision electronic expansion valve, controlling the degree of superheat accurately of the main circuit and auxiliary circuit, to realize the system efficient and stable operation.

Selection of 316L stainless steel brazing plate type economizer

Application of EVI heat pump dedicated compressor, evaporation temperature can extend to -30 degrees C, to improve the heating efficiency under low temperature condition.

Gas spray & enthalpy increase special-purpose compressor

The axial and radial direction flexible technology of Copeland scroll to ensure the compressor with excellent reliability and high efficiency
Wide range of product line
Lower oil circulating rate
Superior liquid impact resistance
Lower noise and vibration level
Low LCCP (Life Cycle Climate Performance)



Patent Electric Valve Reversing Technology

Patent Number: ZL 2011 2 0330413.8

Use patent of electric valve reversing technology, multi channels temperature detecting, intelligent reversing, to realize three functions of making hot water independently, space heating independently and combing the two together.

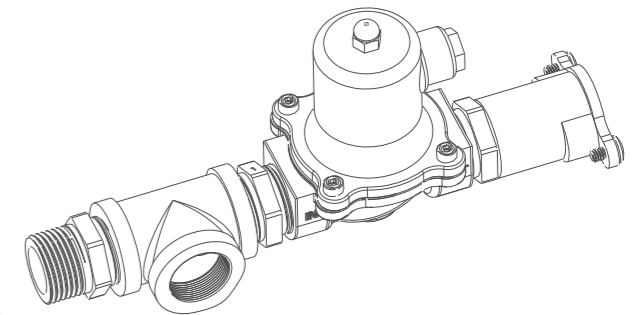

Secondary Heat Exchange Design

Built-in stainless steel heat exchanger for water tank, strong corrosion resistance, not easy to scale, use secondary heat exchange design, effectively prevent the mixture of space heating hot water and domestic use sanitary hot water.

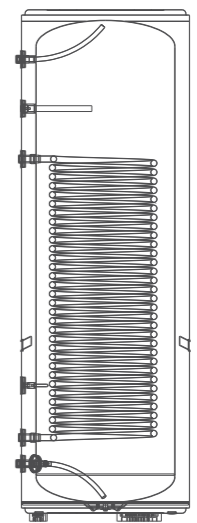

AC Contactor & Relay:

Adopt "Schneider" AC Contactor & relay, model selection according to the current capacity of 1.5 times, to ensure the efficient and stable operation for long time.

D01H series(Air source heat pump for Hot water & Space heating)

FH-150305

	FH03Ps-S5	FH05Ps-S5	FH03P-S5	FH05P-S5	FH07P-S5	
Hot water heating capacity(kW)	12	19	12	19	25	
Space heating capacity(kW)	9	14.5	9	14.5	20	
Input power for hot water heating(kW)	2.79	4.41	2.79	4.41	5.82	
Input current for hot water heating(A)	14.67	23.23	5.27	8.34	11.00	
Input power for space heating(kW)	2.86	4.60	2.82	4.61	6.43	
Input current for space heating(A)	15.06	24.21	5.33	8.71	12.15	
Maximum input power(kW)	3.43	5.52	3.39	5.53	7.72	
Maximum input current(A)	18.07	29.05	6.40	10.46	14.58	
Hot water performance coefficient(COP)	4.31	4.30	4.31	4.30	4.30	
Heating performance coefficient(COP)	3.15	3.15	3.19	3.15	3.11	
Rated hot water output temp.()	55					
Rated output temperature of space heating()	45					
Max. hot water output temp.()	60					
Rated hot water produce capacity(L/h)	258.0	408.5	258.0	408.5	537.5	
Power supply	1N 220V/50Hz		3N 380V/50Hz			
Compressor	Type	Fully closed scroll type				
	Start mode	Directly start				
Water side heat exchanger	Type	Shell and coil heat exchanger				
	Water flow(m³/h)	2.1	3.3	2.1	3.3	4.3
	Water pressure drop(kPa)	40	40	40	40	40
	Pipe size(DN)	25				
Protections	1. High pressure and low pressure protection, 2. Anti-freezing protection, 3. High temperature protection, 4. Too big of the water temperature difference for outlet and inlet protection, 5. Overload protection, 6. Lack phase protection, 7. Reverse phase protection, etc..					
Refrigerant	Type	R410A				
	Throttle type	Electronic expansion valve				
	Quantity(kg)	1.9	2.8	1.9	2.8	4.2
Noise DB(A)	60	63	60	63	65	
Unit dimensions	Length(mm)	835	835	835	835	835
	Width(mm)	410	410	410	410	410
	Height(mm)	1330	1330	1330	1330	1330
Weight(kg)	100	160	100	160	180	

- Hot water standard condition: Initial water temperature 15 , the setting water temperature 55 ;
Dry-bulb temperature 20 , wet bulb temperature 15 .
- Heating standard condition: Dry-bulb temperature 7 , wet bulb temperature 6 ;
Cold water inlet temperature 40 , Hot water outlet temperature 45 ;

The above parameters based on Refrigerant R410A, for parameters based on other refrigerants please contact us.
The above parameters may have some differences from the final product because of products updating, so above information is not the provision of any business contract. Please refer to final product label when buy, or refer to us for any information. Our company keeps the right to interpret.

Hot water heating performance correction coefficient (%)

Ambient temperature()	-7	-2	0	2	7	15	20	35	43
Heating capacity(%)	53.0	57.8	61.5	65.5	78.8	96.0	100.0	115.0	126.0
Power(%)	84.2	88.3	89.7	90.3	93.6	98.0	100.0	105.9	111.0
Energy efficiency ratio (COP)(%)	62.9	65.5	68.6	72.5	84.2	98.0	100.0	108.6	113.5

Hot water heating performance correction coefficient changing curve

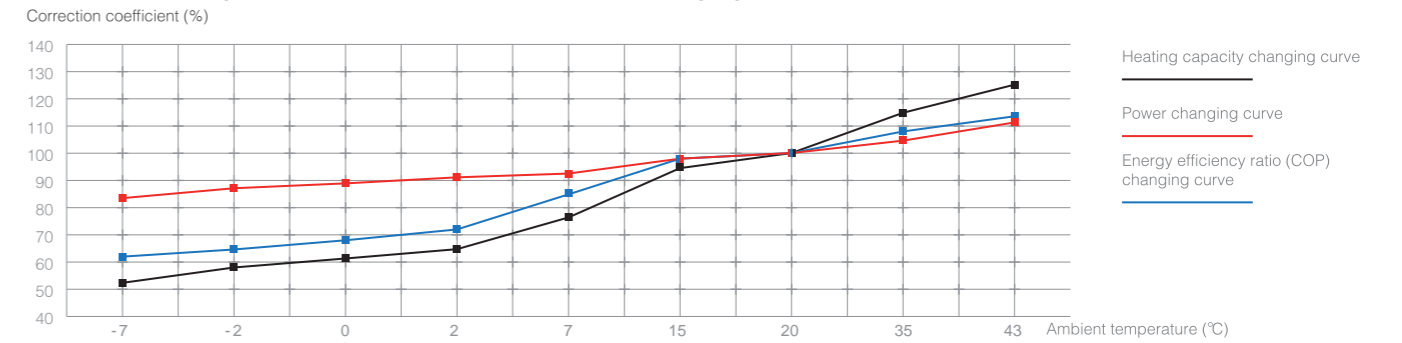

Heating capacity correction coefficient(%)

Outlet hot water temperature (°C)	Ambient temperature (°C)	-10	-7	0	5	7	10	15	20
35		57.1	61.9	76.0	88.0	103.0	110.8	122.0	142.2
40		56.9	62.0	74.0	87.0	102.2	110.1	120.0	140.0
45		56.1	61.0	75.0	85.9	100.0	108.0	119.0	135.0
50		55.0	59.3	71.1	83.6	98.0	103.0	117.0	132.0

Heating capacity correction changing curve

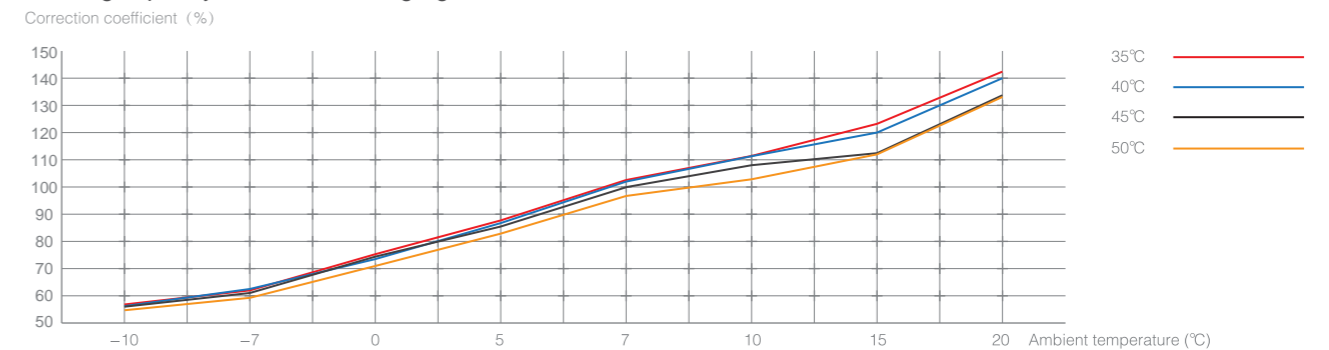

Heating input power correction coefficient(%)

Outlet hot water temperature (°C)	Ambient temperature (°C)	-10	-7	0	5	7	10	15	20
35		78.2	79.6	81.2	83.0	83.0	84.2	85.1	87.6
40		86.1	87.6	88.9	91.0	91.0	92.0	92.1	94.9
45		94.2	95.1	97.6	99.0	100.0	101.1	103.2	103.8
50		103.5	104.1	107.0	109.0	110.0	111.0	112.9	119.0

Heating input power correction changing curve

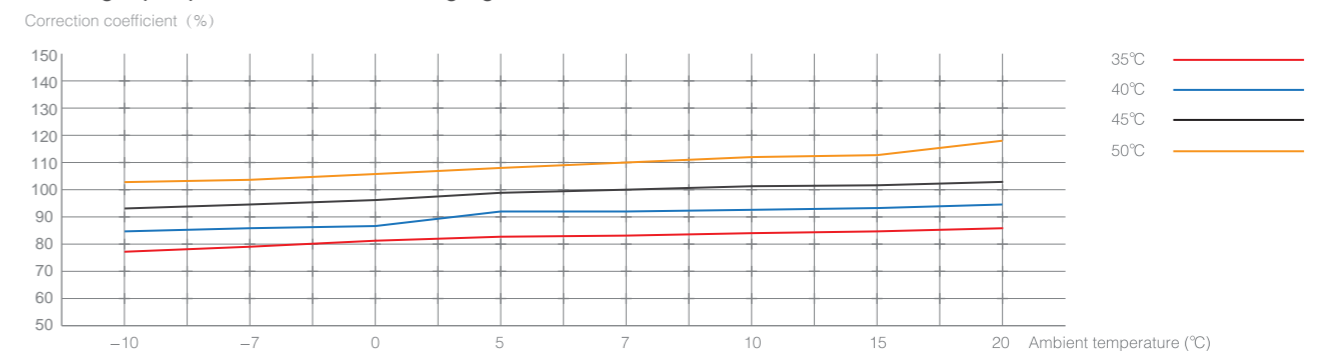

D02H series (High temperature air source heat pump for Hot water & Space heating)

FHH-150305

	FHH03Ps-S5	FHH05Ps-S5	FHH03P-S5	FHH05P-S5	FHH07P-S5	
Hot water heating capacity(kW)	8	13.5	8	13.5	18	
Space heating capacity(kW)	5.5	9.5	5.5	9.5	13	
Input power for hot water heating(kW)	2.20	3.69	2.19	3.67	4.93	
Input current for hot water heating(A)	11.66	19.52	4.13	6.94	9.32	
Input power for space heating(kW)	2.47	4.24	2.46	4.22	5.83	
Input current for space heating(A)	13.33	22.92	4.64	7.98	11.02	
Maximum input power(kW)	2.75	4.61	2.73	4.59	6.16	
Maximum input current(A)	14.58	24.40	5.19	8.72	11.71	
Hot water performance coefficient(COP)	3.63	3.66	3.66	3.68	3.65	
Heating performance coefficient(COP)	2.23	2.24	2.24	2.25	2.23	
Rated hot water output temperature()	75					
Rated output temperature of space heating()	75					
Max. hot water output temp.()	80					
Rated hot water produce capacity	t40(L/H)	172.0	290.3	172.0	290.3	387.0
	t60(L/H)	114.7	193.5	114.7	193.5	258.0
Power supply	1N 220V/50Hz		3N 380V/50Hz			
Compressor	Type	Fully closed scroll type				
	Start mode	Directly start				
Water side heat exchanger	Type	Shell and coil heat exchanger				
	Water flow(m ³ /h)	1.29	2.15	1.29	2.15	3.01
	Water pressure drop(kPa)	40	40	40	40	40
	Pipe size(DN)	25				
Protections	1. High pressure and low pressure protection, 2. Anti-freezing protection, 3. High temperature protection, 4. Too big of the water temperature difference for outlet and inlet protection, 5. Overload protection, 6. Lack phase protection, 7. Reverse phase protection, etc..					
Refrigerant	Type	R134A				
	Throttle type	Electronic expansion valve				
	Quantity(kg)	2.0	3.1	2.0	3.1	4.4
Noise DB(A)	60	63	60	63	65	
Unit dimensions	Length(mm)	835	835	835	835	835
	Width(mm)	410	410	410	410	410
	Height(mm)	1330	1330	1330	1330	1330
Weight(kg)	100	160	100	160	180	

1. Hot water standard condition: Initial water temperature 15 , the setting water temperature 75 ;
Dry-bulb temperature 20 , wet bulb temperature 15 .
2. Heating standard condition: Dry-bulb temperature 7 , wet bulb temperature 6 ,
Cold water inlet temperature 70 , outlet water temperature 75 .

The above parameters based on Refrigerant R134A, for parameters based on other refrigerants please contact us.
The above parameters may have some differences from the final product because of products updating, so above information is not the provision of any business contract. Please refer to final product label when buy, or refer to us for any information. Our company keeps the right to interpret.

Hot water heating performance correction coefficient (%)

Ambient temperature()	-7	-2	0	2	7	15	20	30	43
Heating capacity(%)	38.0	43.8	50.9	61.5	79.8	96.0	100.0	110.0	127.0
Power(%)	85.8	87.3	89.7	90.3	93.6	98.0	100.0	105.0	115.2
Energy efficiency ratio (COP)(%)	44.3	50.2	56.7	68.1	85.3	98.0	100.0	104.8	110.2

Hot water heating performance correction coefficient changing curve

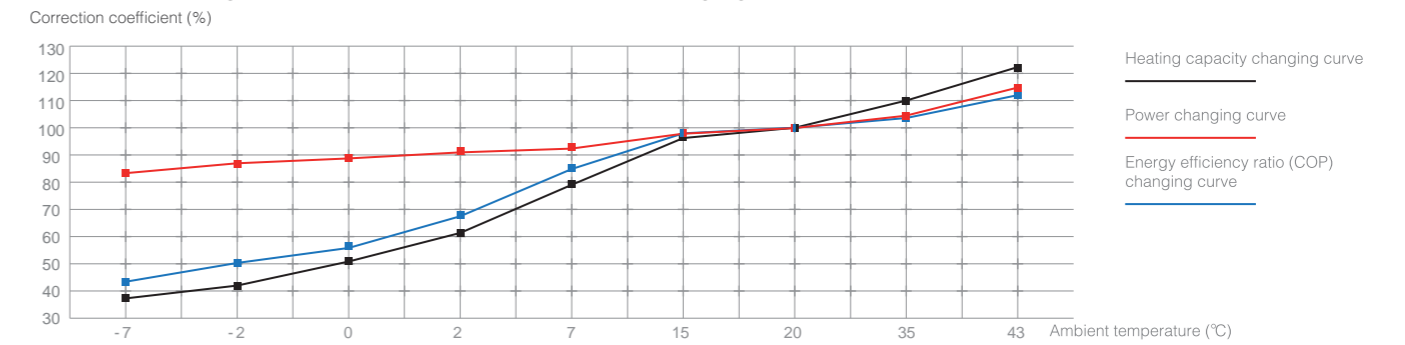

Heating capacity correction coefficient(%)

Outlet hot water temperature (°C)	Ambient temperature (°C)	-7	0	5	7	10	15	20
60		60.3	86.5	101.9	115.8	125.1	143.6	152.8
65		57.8	82.2	98.8	111.3	120.2	138.1	146.9
70		55.2	78.5	94.3	106.2	114.6	131.6	140.2
75		52.0	73.9	88.8	100.0	108.0	124.0	132.5

Heating capacity correction changing curve

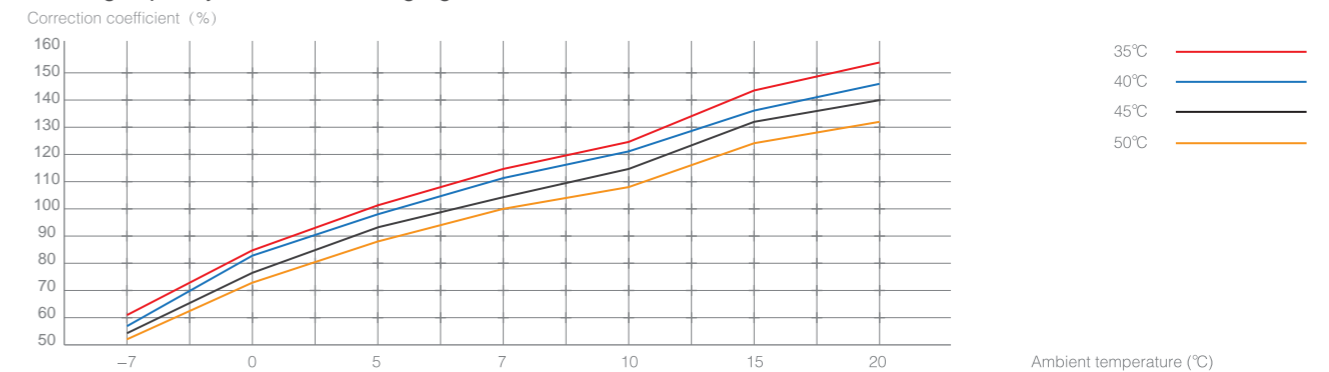

Heating input power correction coefficient(%)

Outlet hot water temperature (°C)	Ambient temperature (°C)	-7	0	5	7	10	15	20
60		71.2	73.9	75.6	75.6	76.7	77.5	79.6
65		78.2	81.2	83.1	83.0	84.3	85.2	87.5
70		86.1	88.5	91.1	91.2	92.2	92.3	95.1
75		94.2	97.3	99.1	100.0	101.3	103.3	104.1

Heating input power correction changing curve

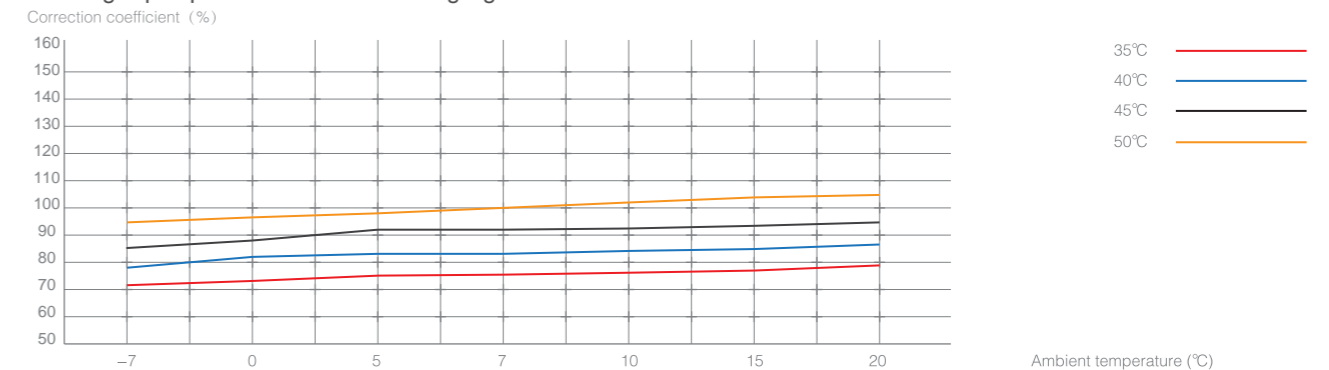

D03H series(EVI Air source heat pump Hot water use & Space heating)

EFH-150307

		EFH3P-S5	EFH5P-S5
Hot water Normal condition	Heating capacity(kW)	12	19
	Input power(kW)	2.80	4.40
	Input current(A)	5.30	8.60
	COP	4.29	4.32
Hot water Nominal condition	Rated heating capacity(kW)	9.50	15.00
	Rated input power(kW)	2.60	4.10
	Rated input current(A)	5.20	8.20
	COP	3.65	3.66
Hot water Low temperature condition	Heating capacity(kW)	5.50	8.80
	Input power(kW)	2.26	3.65
	Input current(A)	4.29	6.93
	COP	2.43	2.41
Space heating standard conditions	Heating capacity(kW)	9	14.5
	Input power(kW)	2.82	4.61
	Input current(A)	5.33	8.71
	COP	3.19	3.15
Maximum input power/current(kW/A)		3.61/6.92	5.71/11.20
Rated hot water output temperature()		55	
Rated space heating water output temperature()		45	
Maximum water output temperature()		60	
Rated hot water produce capacity(L/H)		204.25	322.5
Power supply		3N 380V/50Hz	
Compressor	Type	Fully closed scroll type	
	Start mode	Directly start	
Water side heat exchanger	Type	Shell & coil heat exchanger	
	Water flow(m ³ /h)	2.1	3.3
	Water pressure drop(kPa)	50	55
	Pipe size(DN)	25	25
Middle heat exchanger Type		Brazed plate type heat exchanger	
Protections		1. High pressure and low pressure protection, 2. Anti -freezing protection, 3. High temperature protection, 4. Too big of the water temperature difference for outlet and inlet protection, 5. Overload protection, 6. Lack phase protection, 7. Reverse phase protection, etc..	
Noise DB(A)		55	58
Unit dimensions(mm)		835 × 410 × 1330	
Weight(kg)		115	175

Testing condition:1. Hot water normal condition: dry bulb 20 , wet bulb 15 ; initial water temperature 15 , end water temperature 55 .
2.Hot water nominal condition: dry bulb 7 , wet bulb 6 ; initial water temperature 9 , end water temperature 55 .
3. Hot water low temperature condition: dry bulb -12 , wet bulb -14 ; initial water temperature 9 , end water temperature 55 .
4.Heating standard conditions: dry-bulb temperature 7 , wet bulb temperature 6 ; Cold water inlet temperature 40 , outlet water temperature 45 .

The above parameters may have some differences from the final product because of products updating, so above information is not the provision of any business contract. Please refer to final product label when buy, or refer to us for any information. Our company keeps the right to interpret.

Hot water heating performance correction coefficient (%)

Ambient temperature()	-25	-20	-15	-10	-7	-5	-2	0	2	5	7	10	15	20	25	30	35	38
Heating capacity(%)	40	46	53	60	66	72	77	83	88	94	100	110	114	125	134	142	150	157
Power(%)	88	89.5	91.5	93.5	94	94.3	94.8	95.4	96.5	98	100	105	108	115	121	124	128	133
Energy efficiency ratio (COP)(%)	45	51	58	64	70	76	81	87	91	96	100	105	106	109	111	115	117	118

Hot water heating performance correction coefficient changing curve

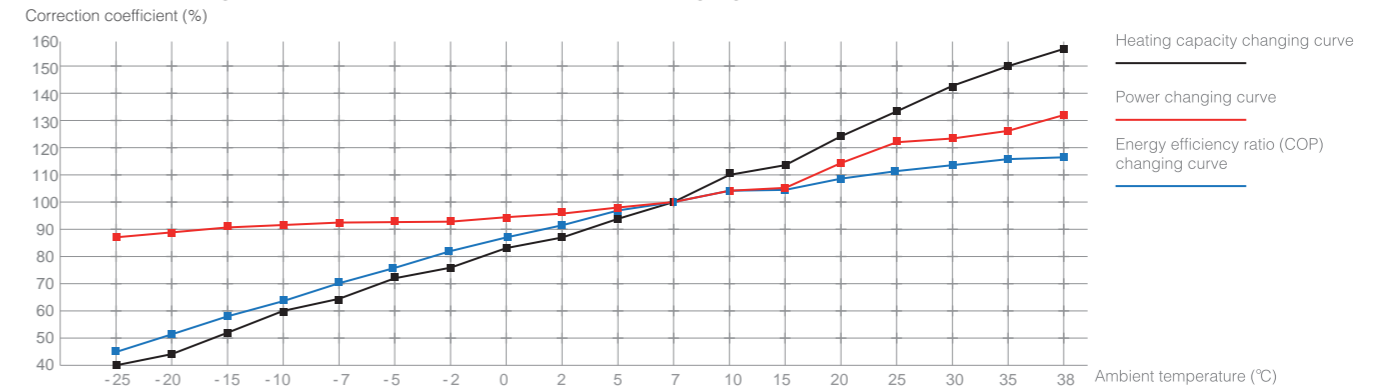

Heating capacity correction coefficient(%)

Outlet hot water temperature (°C)	Ambient temperature (°C)													
	-25	-20	-15	-10	-5	0	5	7	10	15	20	25	30	
35	41.3	47.4	54.6	62.8	70.6	81.9	92.7	97.3	104.3	116.4	129.4	143.5	156.1	
40	41.8	48.0	55.3	63.7	73.0	83.2	94.3	99.0	106.1	118.7	131.8	145.5	159.7	
45	42.3	48.5	55.8	64.2	73.6	84.0	95.2	100.0	107.2	120.0	133.4	147.5	162.1	
50	42.9	49.0	56.2	64.5	73.9	84.3	95.6	100.4	107.7	120.6	134.2	148.5	163.3	

Heating capacity correction changing curve

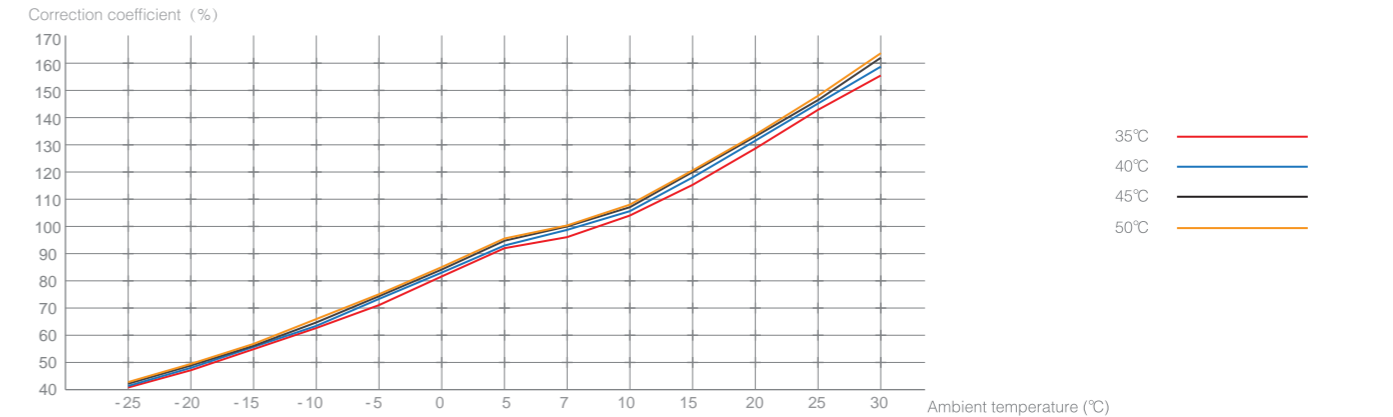

Heating input power correction coefficient(%)

Outlet hot water temperature (°C)	Ambient temperature (°C)													
	-25	-20	-15	-10	-5	0	5	7	10	15	20	25	30	
35	60.2	65.9	71.0	75.4	79.1	81.9	83.8	84.1	84.7	85.2	85.8	86.3	86.7	
40	65.3	71.0	76.3	81.0	85.2	88.6	91.3	92.1	93.3	94.2	95.2	96.1	96.9	
45	72.2	77.6	82.6	87.4	91.8	95.7	98.9	100.0	101.6	103.5	104.7	105.8	106.7	
50	81.1	85.9	90.6	95.2	99.5	103.5	107.1	108.3	110.2	112.8	114.8	116.1	116.7	

Heating input power correction changing curve

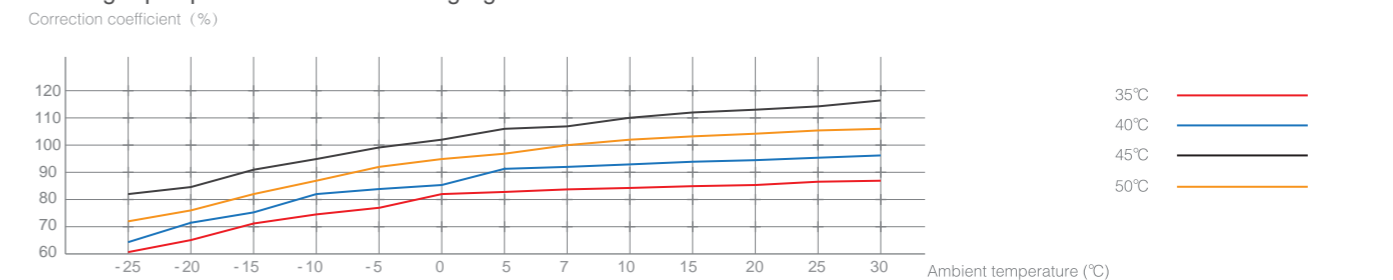

Product Dimensions

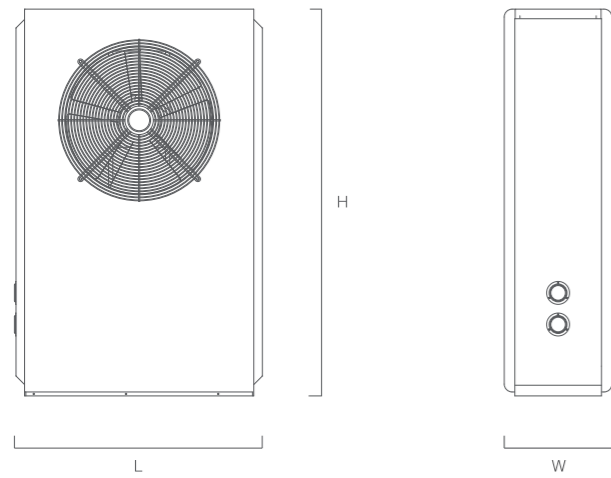

D01H & D02H & D03H series	
Model	Dimensions (L x W x H)
FH03Ps - S5	835 x 410 x 1330
FH05Ps - S5	835 x 410 x 1330
FH03P - S5	835 x 410 x 1330
FH05P - S5	835 x 410 x 1330
FH07P - S5	835 x 410 x 1330
FHH03Ps - S5	835 x 410 x 1330
FHH05Ps - S5	835 x 410 x 1330
FHH03P - S5	835 x 410 x 1330
FHH05P - S5	835 x 410 x 1330
FHH07P - S5	835 x 410 x 1330
EFH3P - S5	835 x 410 x 1330
EFH5P - S5	835 x 410 x 1330

Running Chart

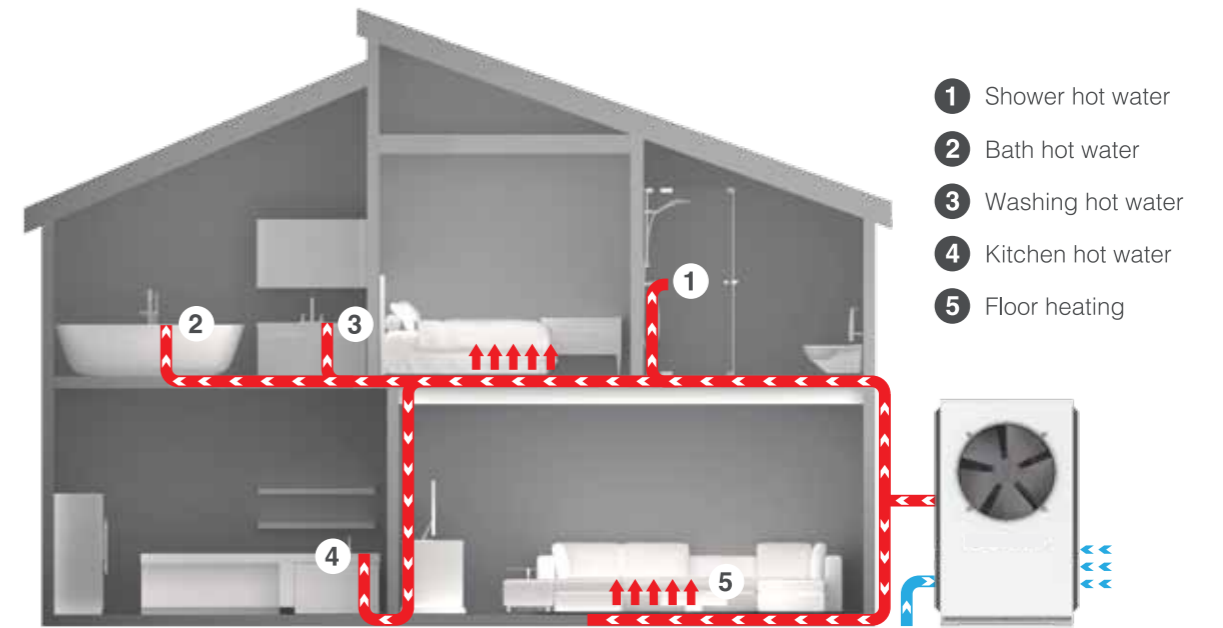
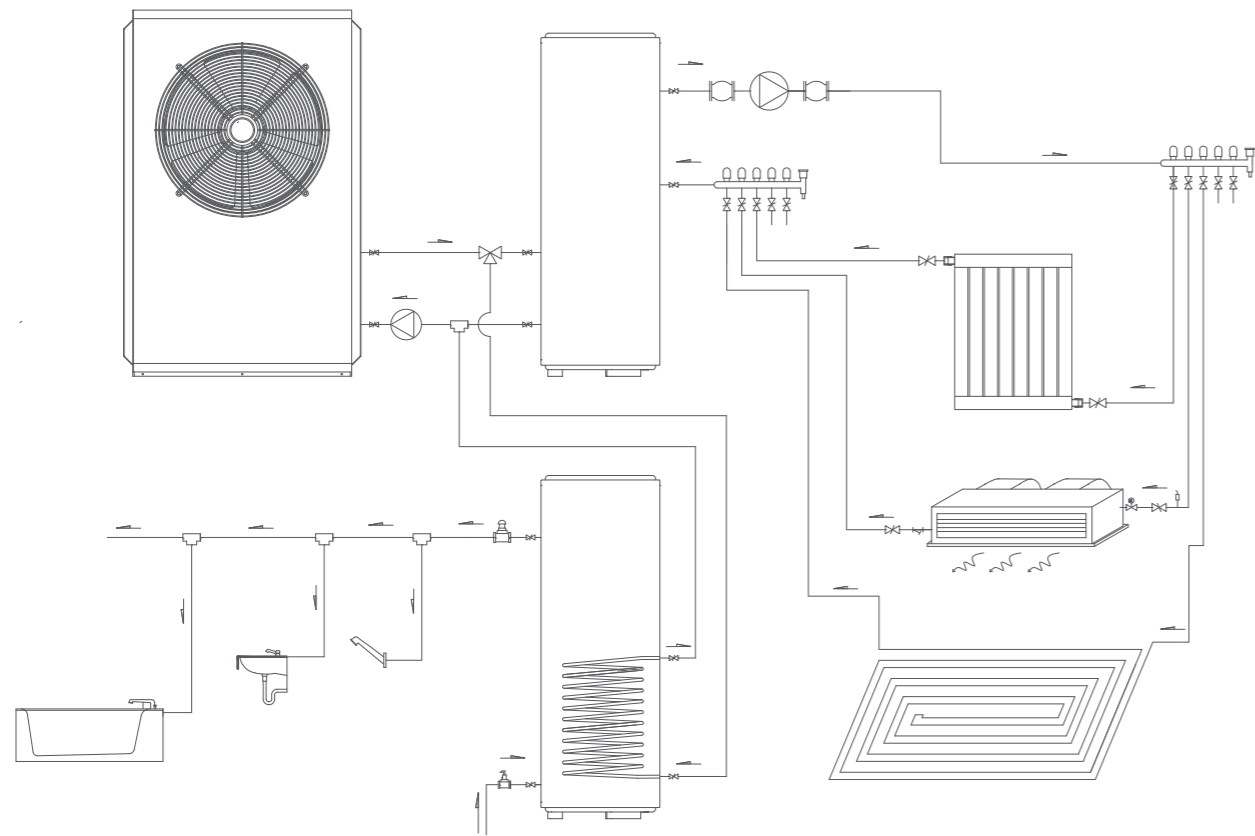

- 1 Shower hot water
- 2 Bath hot water
- 3 Washing hot water
- 4 Kitchen hot water
- 5 Floor heating